

0/1-10V ZigBee + RF + Push Dimmer

Model No.: L1(WZ)

Tuya APP cloud control/Philips HUE control/Voice control/RF dimming/Push Dim/0-10V or 1-10V/Wall junction box mounting



CE RoHS LVD

Features

- ZigBee + RF + AC push 0/1-10V dimmer, 1 channel output.
- Output 1 channel 0/1-10V signal, connect with 0/1-10V dimmable driver.
- Tuya APP cloud control, support on/off, brightness adjust, delay turn on/off light, timer run, scene function.
- Philips HUE APP control by connect with Philips HUE bridge.
- Voice control, support amazon ECHO and TmallGenie smart speaker.
- 0-10V or 1-10V output selectable by DIP switch.
- 256 levels 0-100% dimming smoothly without any flash.
- Compatibility with RF 2.4G single zone or multiple zone dimming remote control.
- Each L1(WZ) controller can also work as ZigBee-RF converter, then use Tuya APP to control one or more RF dimming LED controller or driver synchronously.
- Connect with external push switch to achieve on/off and 0-100% dimming function.
- Light on/off fade time 3s selectable.
- Easy to be placed in standard wall junction box behind a push switch.

Technical Parameters

Input and Output	
Input voltage	AC100-240V
Output signal	0/1-10V (20mA)

Safety and EMC	
EMC standard (EMC)	ETSI EN 301 489-1 V2.2.3 ETSI EN 301 489-17 V3.2.4
Safety standard(LVD)	EN 62368-1:2020+A11:2020
Radio Equipment(RED)	ETSI EN 300 328 V2.2.2
Certification	CE,EMC,LVD,RED

Dimming data	
Input signal	Tuya APP + RF + Push Dim
RF Control distance	30m(Barrier-free space)
Dimming level	256 levels
Dimming range	0-100%

Environment	
Operation temperature	Ta: -30°C ~ +55°C
Case temperature (Max.)	Tc: +65°C
IP rating	IP20

Warranty	
Warranty	5 years

Mechanical Structures and Installations

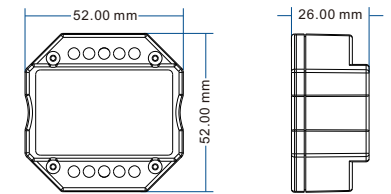
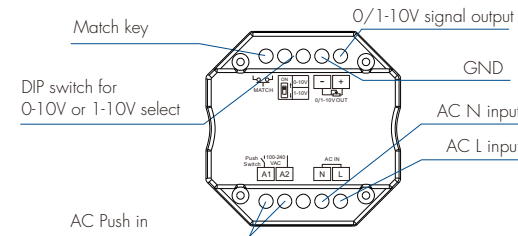

Typical Wall Junction Box Mounting

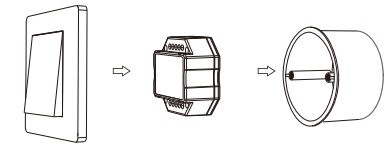

System wiring

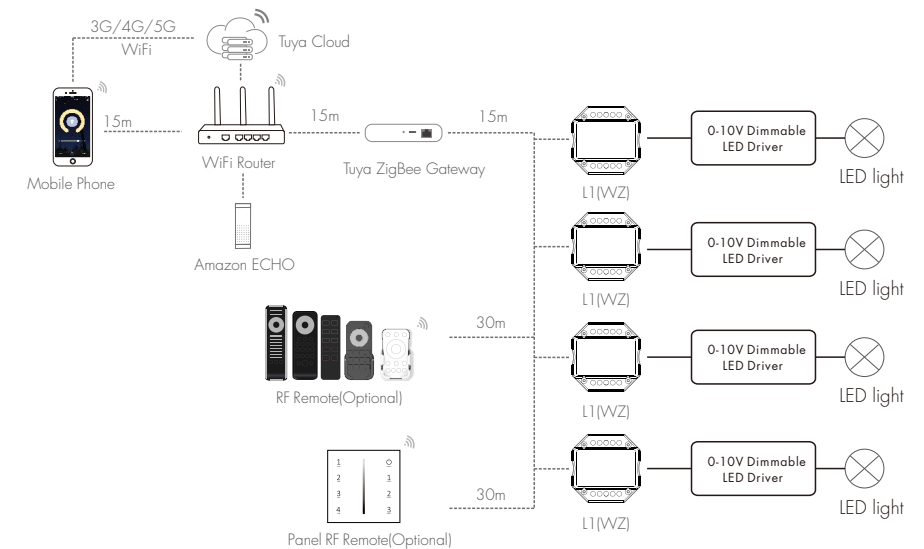

— Wired connection
 Wireless connection

Note:

1. The above distance is measured in spacious (no obstacle) environment, Please refer to the actual test distance before installation.
2. Users must use the Tuya ZigBee gateway to realize remote control and voice control.

Wiring diagram

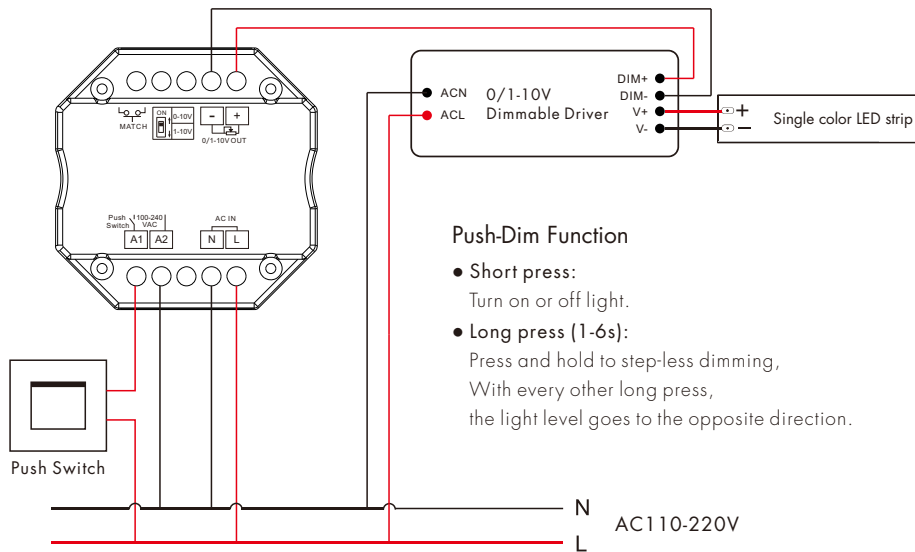

Note: 1. We recommend the number of LED drivers connected to 0/1-10V dimmer does not exceed 50 pieces, The maximum length of the wires from dimmer to LED driver should be no more than 50 meters.
2. Switch off the power, then switch on power, repeat again.
Immediately short press match key 3 times, the light on/off time will change between 3s and 0.5s.

Tuya APP network connection and operation

Press and hold Match/Set key for 2s, reset ZigBee network.

Press and hold Match/Set key for 5s, or push twice Match/Set key fastly, Clear previous network connection, enter config mode, the blue LED indicator fast flash.

Repeat power on and off for 5 consecutive times, also clear previous network connection, enter config mode.

If Tuya APP network connection succeed, the blue LED indicator will stop flash, and in Tuya APP, you can find ZB-DIM device.

Tuya APP interface operation:
Touch brightness slide to adjust brightness.

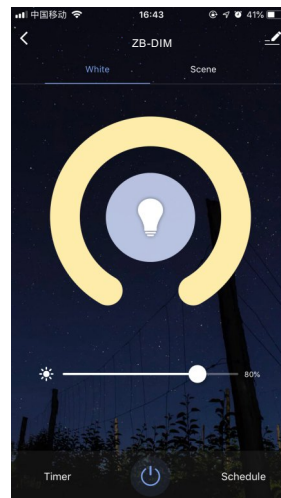

0-10V or 1-10V dimming setting

Select 0-10V dimmer or 1-10V dimmer according to dimmable LED driver.

0-10V Dimmer

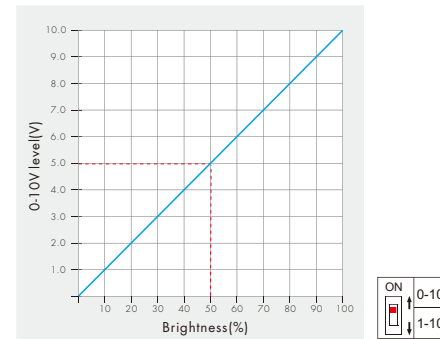

1-10V Dimmer

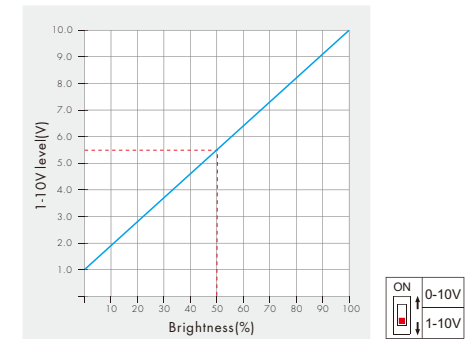

L1(WZ) match RF remote control (Optional)

End user can choose the suitable match/delete ways. Two options are offered for selection:

Use the L1(WZ)'s Match key

Match:
Short press match key of L1(WZ), immediately press on/off key (single zone remote) or zone key (multiple zone remote) on the remote.

Delete:
Press and hold match key of L1(WZ) for 10s to delete all match, The light blinks 5 times means all matched remotes were deleted.

Use Power Restart

Match:
Switch off the power of L1(WZ), then switch on power, repeat again. Immediately short press on/off key (single zone remote) or zone key (multiple zone remote) 3 times on the remote. The light blinks 3 times means match is successful.

Delete:
Switch off the power of L1(WZ), then switch on power, repeat again. Immediately short press on/off key (single zone remote) or zone key (multiple zone remote) 5 times on the remote. The light blinks 5 times means all matched remotes were deleted.

L1(WZ) work as ZigBee-RF converter to match other RF dimming LED controller or driver

End user can choose the suitable match/delete ways. Two options are offered for selection:

Use the controller's Match key

Match:
Short press match key of the controller, immediately press on/off key on the Tuya APP. The LED indicator fast flash a few times means match is successful.

Delete:
Press and hold match key of the controller for 5s, The LED indicator fast flash a few times means match was deleted.

Use Power Restart

Match:
Switch off the power of the controller, then switch on power, repeat again. Immediately short press on/off key 3 times on the Tuya APP. The light blinks 3 times means match is successful.

Delete:
Switch off the power of the controller, then switch on power, repeat again. Immediately short press on/off key 5 times on the Tuya APP. The light blinks 5 times means match was deleted.