

**Constant current independent dimmable driver**  
**KUL Series suffix m(Isolated 1-10V/10V PWM/Rx)**

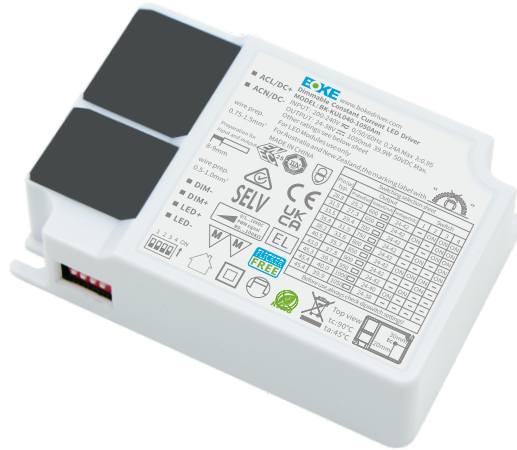

**Features**

- Isolated 1-10V/10V PWM/Rx dimming interface
- 10-level current output can be realized by DIP-switch, easier to adjust the luminaire power
- Soft dimming and flicker-free at any brightness, meets the new requirements of ErP certification
- Using HPC patented technology at any dimming level, The brightness of the lights is the same
- Standby power input<0.5W, meets the ErP requirements of new certification
- High PF, high efficiency, low THD
- Screw-free and pressing type strain relief, easier install
- Independent input and output strain relief, stronger wiring
- Supports 0.75-1.5mm<sup>2</sup> input wires, stronger wiring
- SELV and Class II design, suitable for use side of the light
- Compliance with CE,ENEC,RCM,CCC,UKCA,EL and other certifications
- IP20 protection grade, indoor use
- Nominal life-time up to 100,000 h
- 5-year guarantee

**Interfaces**

- 1-10V 3in1 Isolated(1-10V / 10V PWM / Rx)

**Functions**

- Support central emergency application (dimming normal in DC input)
- Support self-contained emergency application
- Protective features (short-circuit protection, no-load protection)

**Suitable for lights**

- Suitable for lights with independent drivers such as downlights, spotlights, panel lights, etc
- Not suitable for lights with built-in drivers

**Typical applications**

- LED indoor lighting
- LED office lighting
- LED commercial lighting

**Model coding rules of KUL series**

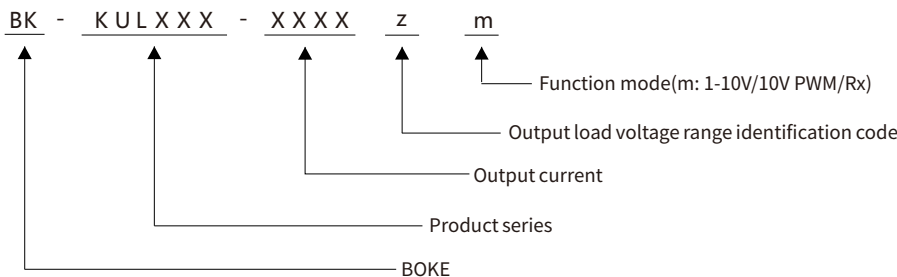

## Function list

Model	Suffix	Wired dimming	Advanced functions
		1-10V 3in1	EL
BK-KUL030 BK-KUL040 BK-KUL050 BK-KUL060	<b>m</b>	√	√

## Model list

Model	Input voltage	Output power	Output voltage	Output current	Dimension	Certifications
BK-KUL030-0800Am	200-240VAC/DC	30.4W MAX.	24-38/40/42VDC	0.35-0.8A	L103*W68.5*H31mm	CE,ENEC,RCM,CCC,UKCA,EL
BK-KUL040-1050Am	200-240VAC/DC	40W MAX.	24-38/40/42VDC	0.6-1.05A	L103*W68.5*H31mm	CE,ENEC,RCM,CCC,UKCA,EL
BK-KUL050-1300Am	200-240VAC/DC	49.4W MAX.	24-38/40/42VDC	0.85-1.3A	L123*W78.5*H31mm	CE,ENEC,RCM,CCC,UKCA,EL
BK-KUL060-1650Am	200-240VAC/DC	62.7W MAX.	24-38/40/42VDC	1.2-1.65A	L123*W78.5*H31mm	CE,ENEC,RCM,CCC,UKCA,EL

## Technical data

Product model	BK-KUL030-0800Am
<b>Output parameters</b>	
Regulation method	Constant Current
Rated output current range	0.35-0.8A
Rated output voltage range	24-38/40/42VDC
Rated output power	30.4W Max
Output current adjustment	DIP S.W(10 levels)
Output current ripple LF	±2%
Output current accuracy	±5%
Linear regulation	±5%
Load regulation	±5%
No load output voltage	50VDC
Flicker-free(typical)	Flickering percent(IEEE 1789)=0.224%, Flicker index(IEEE 1789)=0.000, Pst LM = 0.018, SVM = 0.006, (The above parameters are obtained from testing the panel lights)
<b>Input parameters</b>	
Rated input voltage range	200-240VAC 200-240VDC
Input voltage range	180-264VAC 200-264VDC
Input voltage shock	<380 V AC
Input current	<0.21A (Rated input voltage)
Input frequency	0/50/60Hz
Input PF/Input DF	PF>0.95 (230V AC & Full load),DF>0.95 (230V AC & Full load)
Input THD	10% (230V AC & Full load)
Efficiency(typical)	87% (230V AC & Full load)
In-rush current	15A peak ,254us duration(50 % Ipeak), see the description below for details
Start/Switchover/Turn off	<0.5s(AC start),<0.5s(DC start),<0.3s(AC/DC switchover),<0.5s(Turn off )
Switching cycles	> 50,000 switching cycles
Power consumption	Full load(Pin):34.9W, No load(Pno): N/A, On stand-by(Psb) : <0.5W, Network stand-by(Pnet) : N/A
<b>Safety</b>	
Withstand voltage	I/P-O/P(LED):3750V AC,O/P(LED)-O/P(DIM):1500V AC,I/P-O/P(DIM):1500V AC
Mains surge capability	L-N:2KV(Performance criterion:A)
Leakage current	0.2mA (230V AC & Full load)
Isolation resistance	I/P-O/P:100MΩ/500Vdc/25°C/70% RH
<b>Control interface</b>	
DALI dimming port	N/A
pushDIM dimming port	N/A
1-10V 3in1 dimming port	Voltage range: 0-10V, interface current consumption: 0.3mA
Auxiliary power supply	N/A
Dimming range	5%-100%
Dimming drive mode	AM(amplitude modulation)
<b>Emergency support</b>	
Central emergency system	Supported(dimming normal in DC input)
Self-contained emergency	Supported
<b>Environment &amp; Life time</b>	
Operating temperature	Ta=-20-45°C
Case temperature	Tc=80°C
Operating humidity	5-85% RH, not condensed
Storage temp./humidity	-40-80°C, 5-85% RH, not condensed
IP grade	IP20
MTBF	500,000H,MIL-HDBK-217F(25°C)
Life-time	Nominal life-time up to 100,000 h, see the description below for details
Vibration resistant	10~500Hz,5G 12min./1cycle,period for 72min. each along X,Y,Z axes
Acoustic Noise	<25dB(30cm, Normal operation)
Environmental protection	RoHS
<b>Certifications and standards</b>	
Certification	CE,ENEC,RCM,CCC,UKCA,EL
Safety	EN61347-1, EN61347-2-13, EN62384
EMC	EN55015, EN61000-3-2 , EN61000-3-3, EN61000-4-2,3,4,5,6,8,11, EN61547
DALI-2	N/A
EL	Compatible IEC 61347-2- 13 Annex J , compatible with EN 60598-2-22 and EN 50172
RF	N/A

## Remarks

- By default, all parameter are measured at 230VAC input, full load and 25°C of ambient temperature.
- The driver can not be installed inside the light. when the driver is used with the light, the EMC of the whole light needs to be tested.

## Technical data

Product model	BK-KUL040-1050Am
<b>Output parameters</b>	
Regulation method	Constant Current
Rated output current range	0.6-1.05A
Rated output voltage range	24-38/40/42VDC
Rated output power	40W Max
Output current adjustment	DIP S.W(10 levels)
Output current ripple LF	±2%
Output current accuracy	±5%
Linear regulation	±5%
Load regulation	±5%
No load output voltage	50VDC
Flicker-free(typical)	Flickering percent(IEEE 1789)=0.215%, Flicker index(IEEE 1789)=0.000, Pst LM = 0.016, SVM = 0.004, (The above parameters are obtained from testing the panel lights)
<b>Input parameters</b>	
Rated input voltage range	200-240VAC 200-240VDC
Input voltage range	180-264VAC 200-264VDC
Input voltage shock	<380 V AC
Input current	<0.24A (Rated input voltage)
Input frequency	0/50/60Hz
Input PF/Input DF	PF>0.95 (230V AC & Full load),DF>0.95 (230V AC & Full load)
Input THD	10% (230V AC & Full load)
Efficiency(typical)	88% (230V AC & Full load)
In-rush current	15A peak ,254us duration(50 % Ipeak), see the description below for details
Start/Switchover/Turn off	<0.5s(AC start),<0.5s(DC start),<0.3s(AC/DC switchover),<0.5s(Turn off )
Switching cycles	> 50,000 switching cycles
Power consumption	Full load(Pin):45.4W, No load(Pno): N/A, On stand-by(Psb) : <0.5W, Network stand-by(Pnet) : N/A
<b>Safety</b>	
Withstand voltage	I/P-O/P(LED):3750V AC,O/P(LED)-O/P(DIM):1500V AC,I/P-O/P(DIM):1500V AC
Mains surge capability	L-N:2KV(Performance criterion:A)
Leakage current	0.2mA (230V AC & Full load)
Isolation resistance	I/P-O/P:100MΩ/500Vdc/25°C/70% RH
<b>Control interface</b>	
DALI dimming port	N/A
pushDIM dimming port	N/A
1-10V 3in1 dimming port	Voltage range: 0-10V, interface current consumption: 0.3mA
Auxiliary power supply	N/A
Dimming range	5%-100%
Dimming drive mode	AM(amplitude modulation)
<b>Emergency support</b>	
Central emergency system	Supported(dimming normal in DC input)
Self-contained emergency	Supported
<b>Environment &amp; Life time</b>	
Operating temperature	Ta=-20-45°C
Case temperature	Tc=90°C
Operating humidity	5-85% RH, not condensed
Storage temp./humidity	-40-80°C, 5-85% RH, not condensed
IP grade	IP20
MTBF	500,000H,MIL-HDBK-217F(25°C)
Life-time	Nominal life-time up to 100,000 h, see the description below for details
Vibration resistant	10~500Hz,5G 12min./1cycle,period for 72min. each along X,Y,Z axes
Acoustic Noise	<25dB(30cm, Normal operation)
Environmental protection	RoHS
<b>Certifications and standards</b>	
Certification	CE,ENEC,RCM,CCC,UKCA,EL
Safety	EN61347-1, EN61347-2-13, EN62384
EMC	EN55015, EN61000-3-2 , EN61000-3-3, EN61000-4-2,3,4,5,6,8,11, EN61547
DALI-2	N/A
EL	Compatible IEC 61347-2- 13 Annex J , compatible with EN 60598-2-22 and EN 50172
RF	N/A

## Remarks

- 1.By default, all parameter are measured at 230VAC input, full load and 25°C of ambient temperature.
- 2.The driver can not be installed inside the light. when the driver is used with the light, the EMC of the whole light needs to be tested.

## Technical data

Product model	BK-KUL050-1300Am
<b>Output parameters</b>	
Regulation method	Constant Current
Rated output current range	0.85-1.3A
Rated output voltage range	24-38/40/42VDC
Rated output power	49.4W Max
Output current adjustment	DIP S.W(10 levels)
Output current ripple LF	±2%
Output current accuracy	±5%
Linear regulation	±5%
Load regulation	±5%
No load output voltage	50VDC
Flicker-free(typical)	Flickering percent(IEEE 1789)=0.271%, Flicker index(IEEE 1789)=0.0011, Pst LM = 0.012, SVM = 0.009, (The above parameters are obtained from testing the panel lights)
<b>Input parameters</b>	
Rated input voltage range	200-240VAC 200-240VDC
Input voltage range	180-264VAC 200-264VDC
Input voltage shock	<380 V AC
Input current	<0.29A (Rated input voltage)
Input frequency	0/50/60Hz
Input PF/Input DF	PF>0.95 (230V AC & Full load),DF>0.95 (230V AC & Full load)
Input THD	10% (230V AC & Full load)
Efficiency(typical)	88% (230V AC & Full load)
In-rush current	17A peak ,308us duration(50 % Ipeak), see the description below for details
Start/Switchover/Turn off	<0.5s(AC start),<0.5s(DC start),<0.3s(AC/DC switchover),<0.5s(Turn off )
Switching cycles	> 50,000 switching cycles
Power consumption	Full load(Pin):56.6W, No load(Pno): N/A, On stand-by(Psb) : <0.5W, Network stand-by(Pnet) : N/A
<b>Safety</b>	
Withstand voltage	I/P-O/P(LED):3750V AC,O/P(LED)-O/P(DIM):1500V AC,I/P-O/P(DIM):1500V AC
Mains surge capability	L-N:2KV(Performance criterion:A)
Leakage current	0.14mA (230V AC & Full load)
Isolation resistance	I/P-O/P:100MΩ/500Vdc/25°C/70% RH
<b>Control interface</b>	
DALI dimming port	N/A
pushDIM dimming port	N/A
1-10V 3in1 dimming port	Voltage range: 0-10V, interface current consumption: 0.3mA
Auxiliary power supply	N/A
Dimming range	5%-100%
Dimming drive mode	AM(amplitude modulation)
<b>Emergency support</b>	
Central emergency system	Supported(dimming normal in DC input)
Self-contained emergency	Supported
<b>Environment &amp; Life time</b>	
Operating temperature	Ta=-20-45°C
Case temperature	Tc=80°C
Operating humidity	5-85% RH, not condensed
Storage temp./humidity	-40-80°C, 5-85% RH, not condensed
IP grade	IP20
MTBF	500,000H,MIL-HDBK-217F(25°C)
Life-time	Nominal life-time up to 100,000 h, see the description below for details
Vibration resistant	10~500Hz,5G 12min./1cycle,period for 72min. each along X,Y,Z axes
Acoustic Noise	<25dB(30cm, Normal operation)
Environmental protection	RoHS
<b>Certifications and standards</b>	
Certification	CE,ENEC,RCM,CCC,UKCA,EL
Safety	EN61347-1, EN61347-2-13, EN62384
EMC	EN55015, EN61000-3-2 , EN61000-3-3, EN61000-4-2,3,4,5,6,8,11, EN61547
DALI-2	N/A
EL	Compatible IEC 61347-2- 13 Annex J , compatible with EN 60598-2-22 and EN 50172
RF	N/A

## Remarks

- By default, all parameter are measured at 230VAC input, full load and 25°C of ambient temperature.
- The driver can not be installed inside the light. when the driver is used with the light, the EMC of the whole light needs to be tested.

**Technical data**

Product model	BK-KUL060-1650Am
<b>Output parameters</b>	
Regulation method	Constant Current
Rated output current range	1.2-1.65A
Rated output voltage range	24-38/40/42VDC
Rated output power	62.7W Max
Output current adjustment	DIP S.W(10 levels)
Output current ripple LF	±2%
Output current accuracy	±5%
Linear regulation	±5%
Load regulation	±5%
No load output voltage	50VDC
Flicker-free(typical)	Flickering percent(IEEE 1789)=0.178%, Flicker index(IEEE 1789)=0.000, Pst LM = 0.014, SVM = 0.004, (The above parameters are obtained from testing the panel lights)
<b>Input parameters</b>	
Rated input voltage range	200-240VAC 200-240VDC
Input voltage range	180-264VAC 200-264VDC
Input voltage shock	<380 V AC
Input current	<0.37A (Rated input voltage)
Input frequency	0/50/60Hz
Input PF/Input DF	PF>0.95 (230V AC & Full load),DF>0.95 (230V AC & Full load)
Input THD	10% (230V AC & Full load)
Efficiency(typical)	89% (230V AC & Full load)
In-rush current	23A peak ,338us duration(50 % Ipeak), see the description below for details
Start/Switchover/Turn off	<0.5s(AC start),<0.5s(DC start),<0.3s(AC/DC switchover),<0.5s(Turn off )
Switching cycles	> 50,000 switching cycles
Power consumption	Full load(Pin):69.7W, No load(Pno): N/A, On stand-by(Psb) : <0.5W, Network stand-by(Pnet) : N/A
<b>Safety</b>	
Withstand voltage	I/P-O/P(LED):3750V AC,O/P(LED)-O/P(DIM):1500V AC,I/P-O/P(DIM):1500V AC
Mains surge capability	L-N:2KV(Performance criterion:A)
Leakage current	0.29mA (230V AC & Full load)
Isolation resistance	I/P-O/P:100MΩ/500Vdc/25°C/70% RH
<b>Control interface</b>	
DALI dimming port	N/A
pushDIM dimming port	N/A
1-10V 3in1 dimming port	Voltage range: 0-10V, interface current consumption: 0.3mA
Auxiliary power supply	N/A
Dimming range	5%-100%
Dimming drive mode	AM(amplitude modulation)
<b>Emergency support</b>	
Central emergency system	Supported(dimming normal in DC input)
Self-contained emergency	Supported
<b>Environment &amp; Life time</b>	
Operating temperature	Ta=-20-45°C
Case temperature	Tc=90°C
Operating humidity	5-85% RH, not condensed
Storage temp./humidity	-40-80°C, 5-85% RH, not condensed
IP grade	IP20
MTBF	500,000H,MIL-HDBK-217F(25°C)
Life-time	Nominal life-time up to 100,000 h, see the description below for details
Vibration resistant	10~500Hz,5G 12min./1cycle,period for 72min. each along X,Y,Z axes
Acoustic Noise	<25dB(30cm, Normal operation)
Environmental protection	RoHS
<b>Certifications and standards</b>	
Certification	CE,ENEC,RCM,CCC,UKCA,EL
Safety	EN61347-1, EN61347-2-13, EN62384
EMC	EN55015, EN61000-3-2 , EN61000-3-3, EN61000-4-2,3,4,5,6,8,11, EN61547
DALI-2	N/A
EL	Compatible IEC 61347-2- 13 Annex J , compatible with EN 60598-2-22 and EN 50172
RF	N/A

**Remarks**

- By default, all parameter are measured at 230VAC input, full load and 25°C of ambient temperature.
- The driver can not be installed inside the light. when the driver is used with the light, the EMC of the whole light needs to be tested.

Electrical values

**BK-KUL030-0800Am**

Efficiency vs Voltage

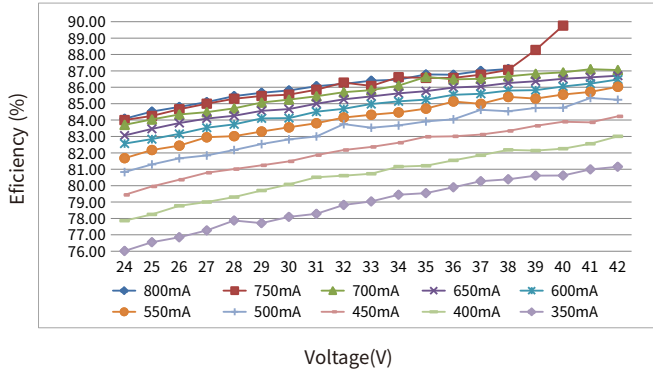

THD vs. Voltage

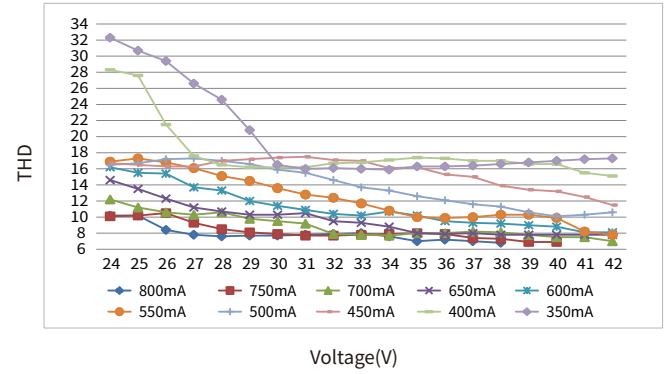

Power factor vs. Voltage

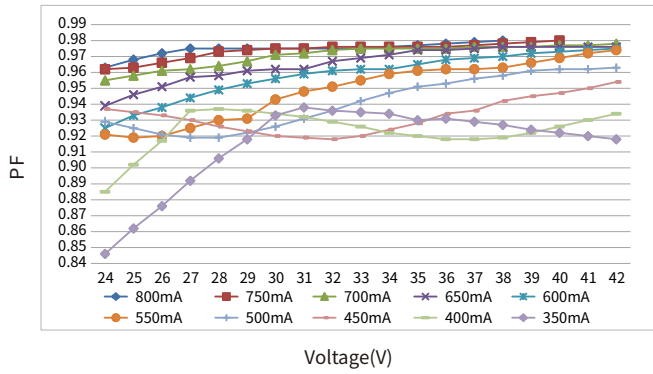

Displacement factor vs. voltage

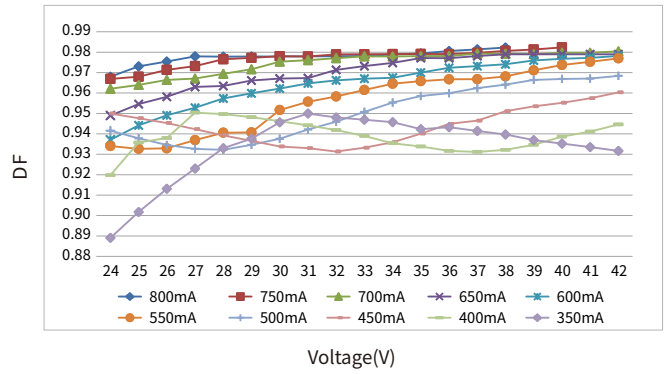

**BK-KUL040-1050Am**

Efficiency vs Voltage

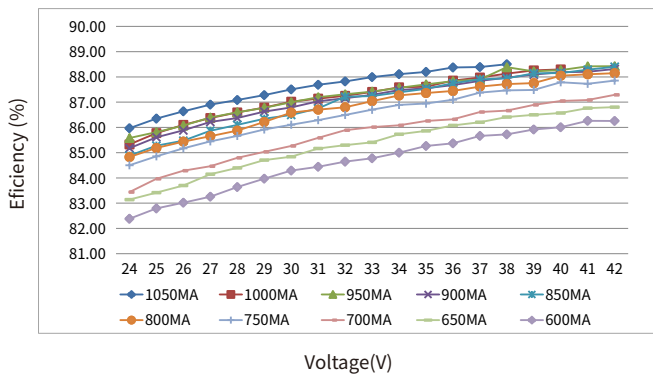

THD vs. Voltage

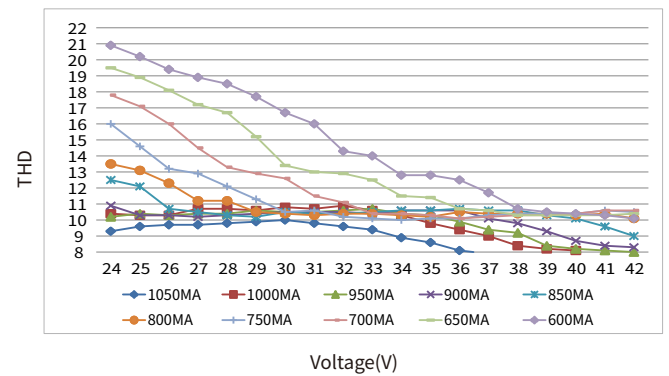

Power factor vs. Voltage

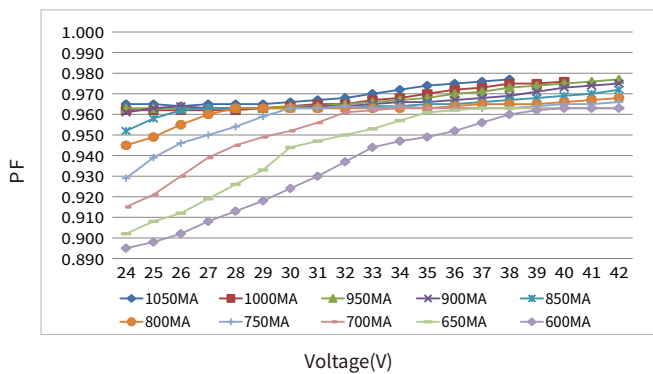

Displacement factor vs. voltage

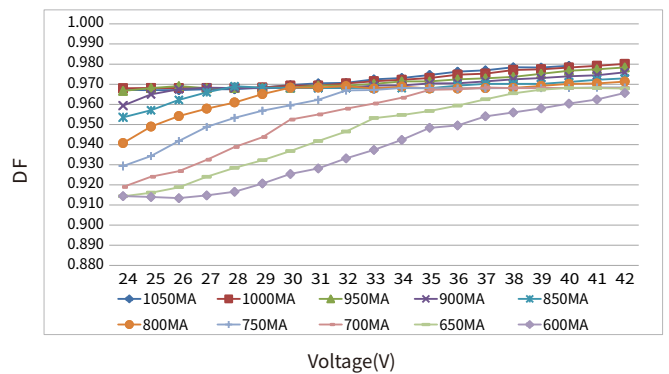

Electrical values

**BK-KUL050-1300Am**

Efficiency vs Voltage

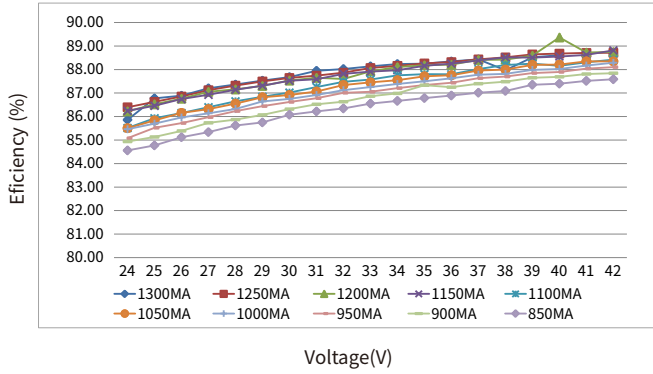

THD vs. Voltage

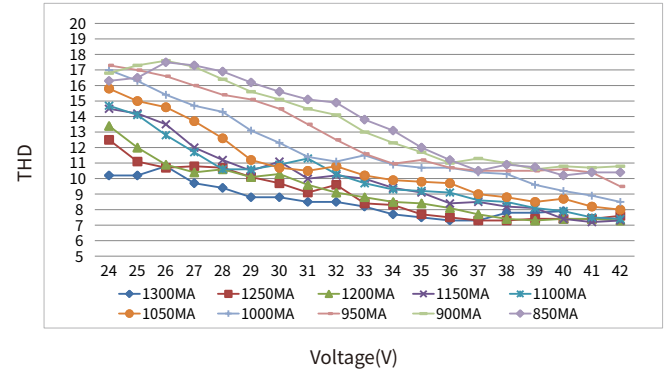

Power factor vs. Voltage

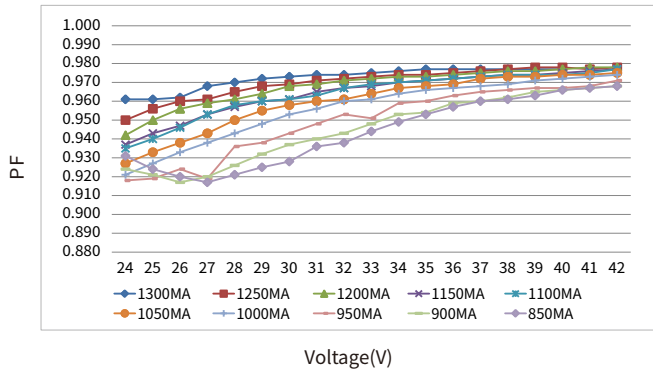

Displacement factor vs. voltage

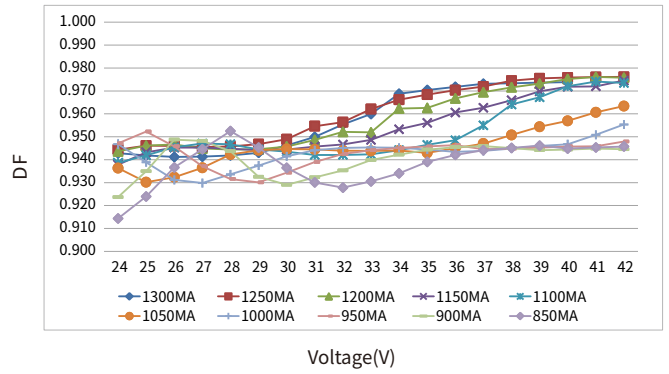

**BK-KUL060-1650Am**

Efficiency vs Voltage

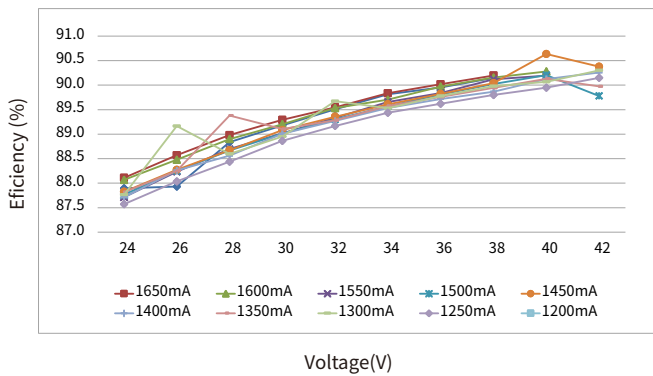

THD vs. Voltage

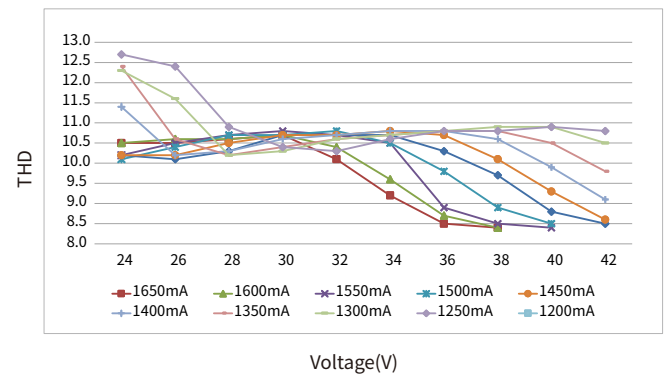

Power factor vs. Voltage

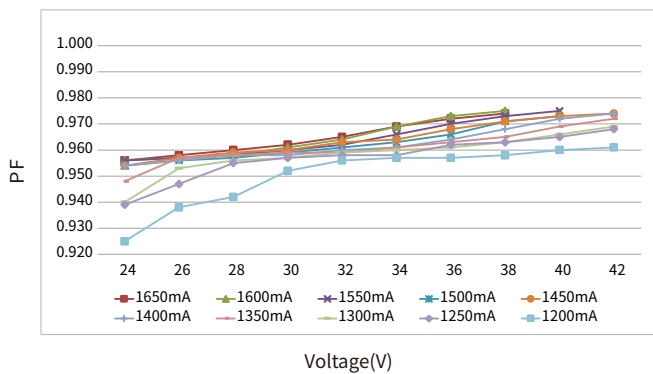

Displacement factor vs. voltage

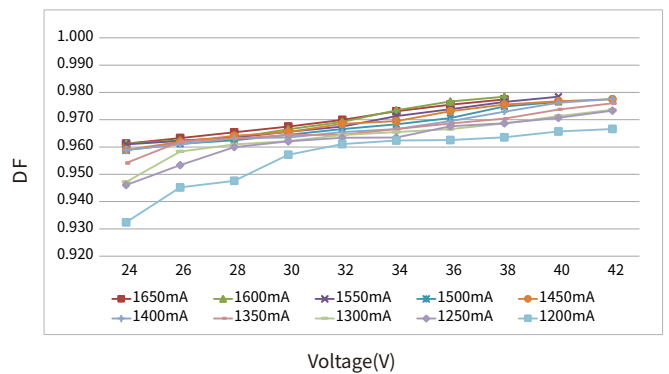



**Expected life-time**

BK-KUL030-0800Am

Life-time vs. case temperature

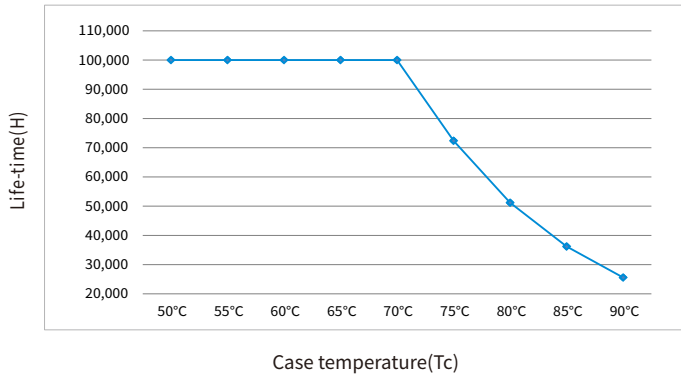

BK-KUL040-1050Am

Life-time vs. case temperature

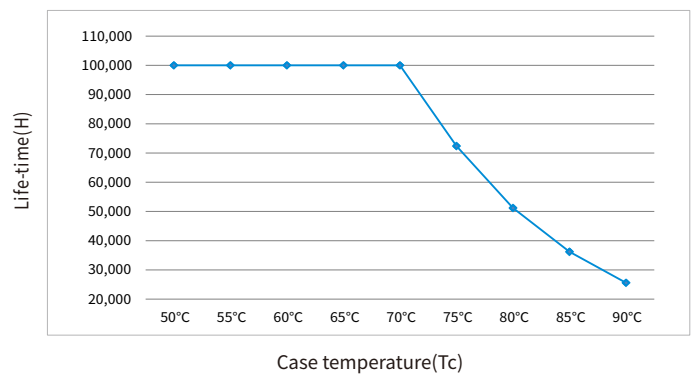

BK-KUL050-1300Am

Life-time vs. case temperature

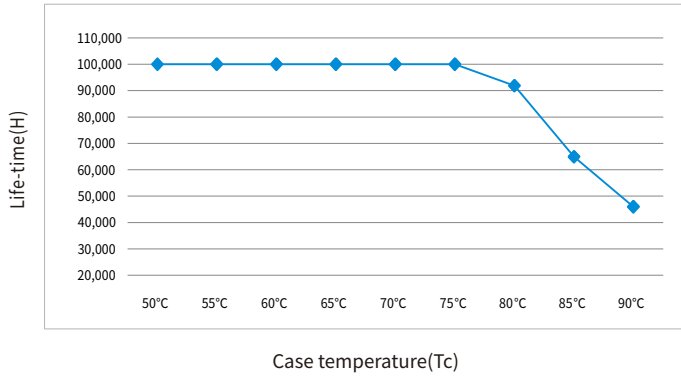

BK-KUL060-1650Am

Life-time vs. case temperature

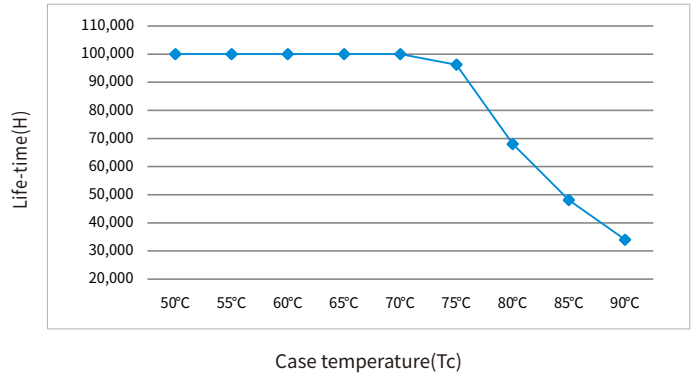

- The life-time of the LED driver is shown in the figure above (calculated based on the 90% survival rate).
- The relation of tc to ta temperature depends also on the luminaire design.

**Surge**

Model	Ipeak	Twidth	Condition	Relative number of MCB/pcs														
				B10	B13	B16	B20	B25	C10	C13	C16	C20	C25	D10	D13	D16	D20	D25
BK-KUL030-0800Am	15A	254us	AC 230V, Full load, Cold start, Ta ≤ 30°C, MCB is not installed side by side	16	21	25	32	40	26	34	42	53	66	44	57	70	88	110
BK-KUL040-1050Am	15A	254us		16	21	25	32	40	26	34	42	53	66	34	44	54	67	84
BK-KUL050-1300Am	17A	308us		11	14	17	22	27	18	24	29	36	45	27	35	43	54	68
BK-KUL060-1650Am	23A	338us		7	10	12	15	18	12	16	20	25	31	22	29	35	44	55

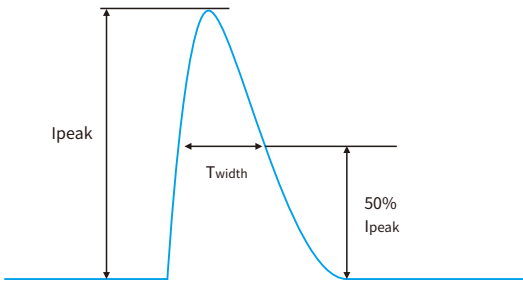

**Remarks**

- The number of drives mounted under different MCBs in the table is the maximum value. Please do not exceed this number during installation.
- Calculation uses typical values from ABB series S200 as a reference.
- Different brands and models of miniature circuit breakers, the number of drives mounted will be slightly different.
- If the ambient temperature of the MCB installation exceeds 30°C or multiple MCBs are installed side by side, the number of drives mounted will be reduced and the calculation needs to be recalculated.
- Electrician's usually consider Type B for household lighting and Type C for commercial lighting application.

**Functions**

**Output short-circuit behaviour**

- Output short-circuit will not damage the driver.
- After removing the short circuit fault, the driver will automatically resume output.

**Output no-load operation**

- Output no-load will not damage the driver.
- Please turn off the driver first if you need to connect the LED load.

**DIP-switch & output current**

**BK-KUL030-0800Am**

Pin(w) typ.	Output			1	2	3	4
	Prated(W)	Irated(mA)	Voltage(Vdc)				
18.1	14.7	350	24-42	--	ON	ON	ON
19.5	16.8	400	24-42	ON	--	ON	ON
22.1	18.9	450	24-42	--	--	ON	ON
24.6	21.0	500	24-42	--	ON	--	ON
26.8	23.1	550	24-42	--	--	--	ON
29.1	25.2	600	24-42	ON	ON	ON	--
31.4	27.3	650	24-42	--	--	ON	--
33.8	29.4	700	24-42	--	ON	--	--
34.4	30.0	750	24-40	ON	--	--	--
34.9	30.4	800 ★	24-38	--	--	--	--

**BK-KUL040-1050Am**

Pin(w) typ.	Output			1	2	3	4
	Prated(W)	Irated(mA)	Voltage(Vdc)				
28.8	25.2	600	24-42	--	ON	ON	ON
31.5	27.3	650	24-42	ON	--	ON	ON
33.5	29.4	700	24-42	--	--	ON	ON
35.8	31.5	750	24-42	--	ON	--	ON
38.2	33.6	800	24-42	--	--	--	ON
40.5	35.7	850	24-42	ON	ON	ON	--
43.0	37.8	900	24-42	--	--	ON	--
45.3	39.9	950	24-42	--	ON	--	--
45.4	40.0	1000	24-40	ON	--	--	--
45.4	39.9	1050 ★	24-38	--	--	--	--

**BK-KUL050-1300Am**

Pin(w) typ.	Output			1	2	3	4
	Prated(W)	Irated(mA)	Voltage(Vdc)				
40.4	35.7	850	24-42	--	ON	ON	ON
42.8	37.8	900	24-42	ON	--	ON	ON
45.0	39.9	950	24-42	--	--	ON	ON
47.4	42.0	1000	24-42	--	ON	--	ON
49.4	44.1	1050	24-42	--	--	--	ON
52.1	46.2	1100	24-42	ON	ON	ON	--
54.1	48.3	1150	24-42	--	--	ON	--
56.6	50.4	1200	24-42	--	ON	--	--
56.2	50.0	1250	24-40	ON	--	--	--
56.4	49.4	1300 ★	24-38	--	--	--	--

**BK-KUL060-1650Am**

Pin(w) typ.	Output			1	2	3	4
	Prated(W)	Irated(mA)	Voltage(Vdc)				
56.0	50.4	1200	24-42	--	ON	ON	ON
58.3	52.5	1250	24-42	ON	--	ON	ON
60.7	54.6	1300	24-42	--	--	ON	ON
63.0	56.7	1350	24-42	--	ON	--	ON
65.3	58.8	1400	24-42	--	--	--	ON
67.7	60.9	1450	24-42	ON	ON	ON	--
66.7	60.0	1500	24-40	--	--	ON	--
68.9	62.0	1550	24-40	--	ON	--	--
67.6	60.8	1600	24-38	ON	--	--	--
69.7	62.7	1650 ★	24-38	--	--	--	--

**Remarks:**

- ★ It means that this item is the factory default current.
- It means that this channel is OFF.

Label

BK-KUL030-0800Am

**BOKE** www.bokedriver.com  
**Dimmable Constant Current LED Driver**  
**MODEL: BK-KUL030-0800Am**  
**ACN/DC-** INPUT: 200-240V  $\approx$  0/50/60Hz 0.21A Max  $\lambda$ :0.95  
 OUTPUT: 24-38V  $\approx$  800mA 30.4W 50VDC Max.  
 Other ratings see below sheet

wire prep. For LED Modules use only  
 0.75-1.5mm<sup>2</sup> For Australia and New Zealand, the marking label with

Preparation for input and output  
 8-9mm

wire prep. For LED Modules use only  
 0.5-1.0mm<sup>2</sup>

■ DIM-  
 ■ DIM+  
 ■ LED+  
 ■ LED-

Pin(w) typ.	Prated(W)	Irated(mA)	Voltage(Vdc)	Switch			
				1	2	3	4
18.1	14.7	350	24-42	-	ON	ON	ON
19.5	16.8	400	24-42	ON	-	ON	ON
22.1	18.9	450	24-42	-	ON	ON	ON
24.6	21.0	500	24-42	-	ON	ON	ON
26.8	23.1	550	24-42	-	ON	ON	ON
29.1	25.2	600	24-42	ON	ON	ON	-
31.4	27.3	650	24-42	-	ON	ON	-
33.8	29.4	700	24-42	-	ON	ON	-
34.4	30.0	750	24-40	ON	ON	-	-
34.9	30.4	800	24-38	-	-	-	-

Before use, always check dipswitch settings!

Top view  
 tc:80°C  
 ta:45°C

BK-KUL040-1050Am

**BOKE** www.bokedriver.com  
**Dimmable Constant Current LED Driver**  
**MODEL: BK-KUL040-1050Am**  
**ACN/DC-** INPUT: 200-240V  $\approx$  0/50/60Hz 0.24A Max  $\lambda$ :0.95  
 OUTPUT: 24-38V  $\approx$  1050mA 39.9W 50VDC Max.  
 Other ratings see below sheet

wire prep. For LED Modules use only  
 0.75-1.5mm<sup>2</sup> For Australia and New Zealand, the marking label with

Preparation for input and output  
 8-9mm

wire prep. For LED Modules use only  
 0.5-1.0mm<sup>2</sup>

■ DIM-  
 ■ DIM+  
 ■ LED+  
 ■ LED-

Pin(w) typ.	Prated(W)	Irated(mA)	Voltage(Vdc)	Switch			
				1	2	3	4
28.8	25.2	600	24-42	-	ON	ON	ON
31.5	27.3	650	24-42	ON	-	ON	ON
33.5	29.4	700	24-42	-	ON	ON	ON
35.8	31.5	750	24-42	-	ON	ON	ON
38.2	33.6	800	24-42	-	ON	ON	ON
40.5	35.7	850	24-42	ON	ON	ON	-
43.0	37.8	900	24-42	-	ON	ON	-
45.3	39.9	950	24-42	-	ON	ON	-
45.4	40.0	1000	24-40	ON	ON	-	-
45.4	39.9	1050	24-38	-	-	-	-

Before use, always check dipswitch settings!

Top view  
 tc:90°C  
 ta:45°C

BK-KUL050-1300Am

**BOKE** www.bokedriver.com  
**Dimmable Constant Current LED Driver**  
**MODEL: BK-KUL050-1300Am**  
**ACN/DC-** INPUT: 200-240V  $\approx$  0/50/60Hz 0.29A Max  $\lambda$ : 0.95  
 OUTPUT: 24-38V  $\approx$  1300mA 49.4W 50VDC Max.  
 Other ratings see below sheet

wire prep. For LED Modules use only  
 0.75-1.5mm<sup>2</sup> For Australia and New Zealand, the marking label with

Preparation for input and output  
 8-9mm

wire prep. For LED Modules use only  
 0.5-1.0mm<sup>2</sup>

■ DIM-  
 ■ DIM+  
 ■ LED+  
 ■ LED-

Pin(w) typ.	Prated(W)	Irated(mA)	Voltage(Vdc)	Switch			
				1	2	3	4
40.4	35.7	850	24-42	-	ON	ON	ON
42.8	37.8	900	24-42	ON	-	ON	ON
45.0	39.9	950	24-42	-	ON	ON	ON
47.4	42.0	1000	24-42	-	ON	ON	ON
49.7	44.1	1050	24-42	-	-	-	ON
52.1	46.2	1100	24-42	ON	ON	ON	-
54.1	48.3	1150	24-42	-	-	ON	-
56.6	50.4	1200	24-42	-	ON	-	-
56.2	50.0	1250	24-40	ON	-	-	-
56.4	49.4	1300	24-38	-	-	-	-

Before use, always check dipswitch settings!

Top view  
 tc:80°C  
 ta:45°C

BK-KUL060-1650Am

**BOKE** www.bokedriver.com  
**Dimmable Constant Current LED Driver**  
**MODEL: BK-KUL060-1650Am**  
**ACN/DC-** INPUT: 200-240V  $\approx$  0/50/60Hz 0.37A Max  $\lambda$ : 0.95  
 OUTPUT: 24-38V  $\approx$  1650mA 62.7W 50VDC Max.  
 Other ratings see below sheet

wire prep. For LED Modules use only  
 0.75-1.5mm<sup>2</sup> For Australia and New Zealand, the marking label with

Preparation for input and output  
 8-9mm

wire prep. For LED Modules use only  
 0.5-1.0mm<sup>2</sup>

■ DIM-  
 ■ DIM+  
 ■ LED+  
 ■ LED-

Pin(w) typ.	Prated(W)	Irated(mA)	Voltage(Vdc)	Switch			
				1	2	3	4
56.0	50.4	1200	24-42	-	ON	ON	ON
58.3	52.5	1250	24-42	ON	-	ON	ON
60.7	54.6	1300	24-42	-	ON	ON	ON
63.0	56.7	1350	24-42	-	ON	ON	ON
65.3	58.8	1400	24-42	-	-	-	ON
67.7	60.9	1450	24-42	ON	ON	ON	-
66.7	60.0	1500	24-40	-	-	ON	-
68.9	62.0	1550	24-40	-	ON	-	-
67.6	60.8	1600	24-38	ON	-	-	-
69.7	62.7	1650	24-38	-	-	-	-

Before use, always check dipswitch settings!

Top view  
 tc:90°C  
 ta:45°C

Insulation between circuits

Isolation	Input	Output	Case	DIM
Input	-	Double	Double	Basic
Output	Double	-	Basic	Basic
Case	Double	Basic	-	Basic

## 1-10V/10V PWM dimming application

Wiring diagram

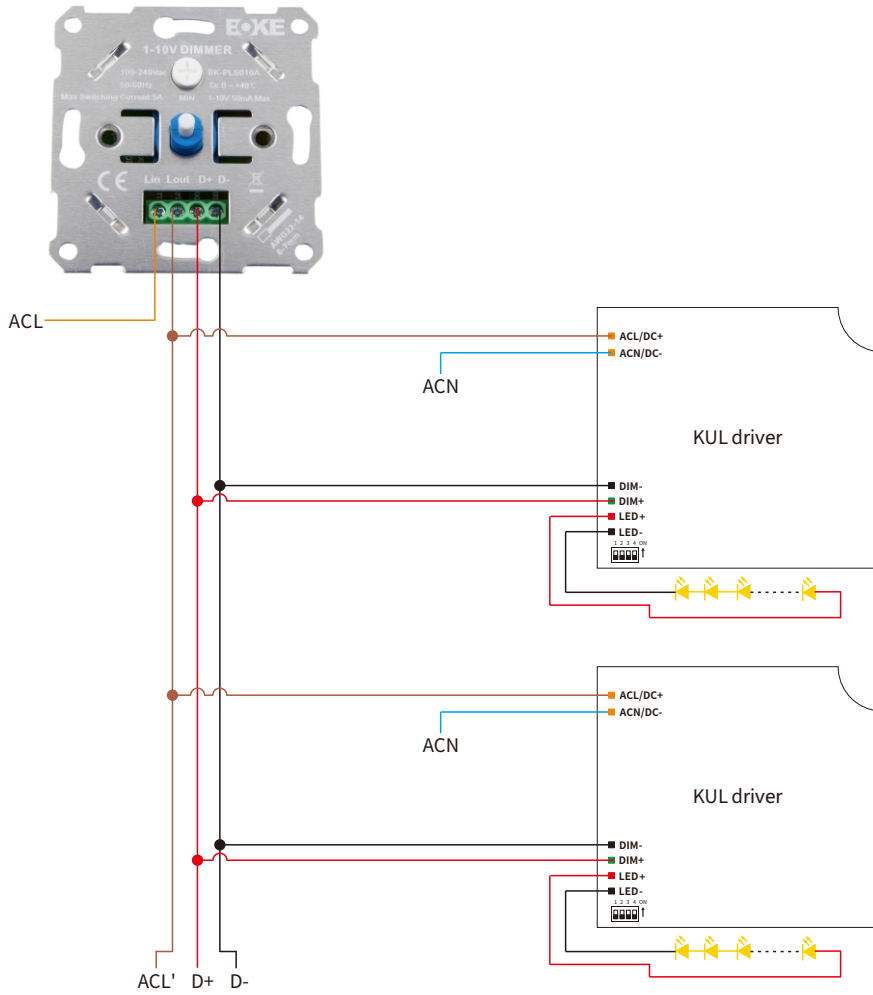

### Remarks

- Dimming interface characteristics: 0.9V and below are closed, 1V is the darkest, 10V is the brightest, 1-10V is the dimming range.
- The dimming interface distinguishes between positive and negative, DIM+ is positive, DIM- is negative, please do not reverse.
- Dimming interface does not support voltage access higher than 20V, otherwise it will cause damage to the internal components.
- When the dimming interface is open, the driver outputs the maximum current. When the interface is short-circuited, the current output is closed.
- When multiple synchronous dimming is required, the positive poles of the dimming interface of each driver are connected together, and the negative poles are connected together.
- Support passive dimmer or isolated active dimmer dimming, does not support non-isolated active dimmer dimming.
- In general, it is recommended that the number of mounted drives does not exceed 30pcs, and the wiring length does not exceed 100m.
- It is recommended that the dimming wires should not be lower than the 22AWG wire.
- Do not put the dimming wires with high voltage or interference sources. If it is unavoidable, please use the shielded wires.
- If you need a drive with 0-10V dimming characteristics, please contact BOKE.

### Dimming curve

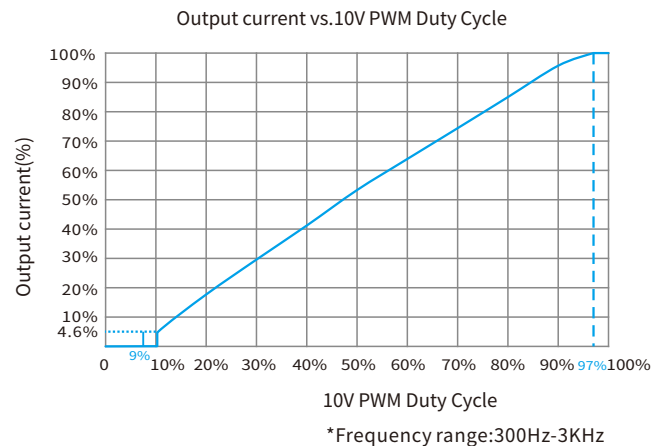
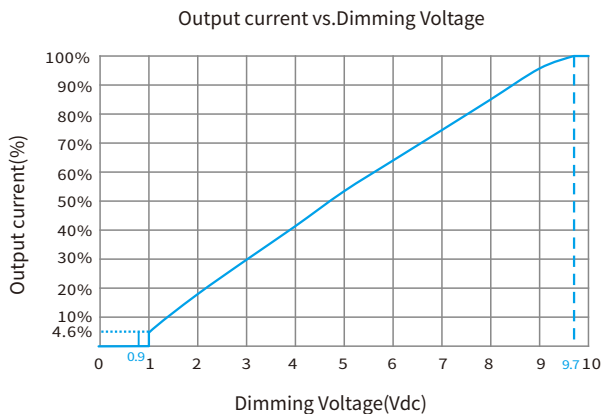

## 100K potentiometer dimming application

### Wiring diagram

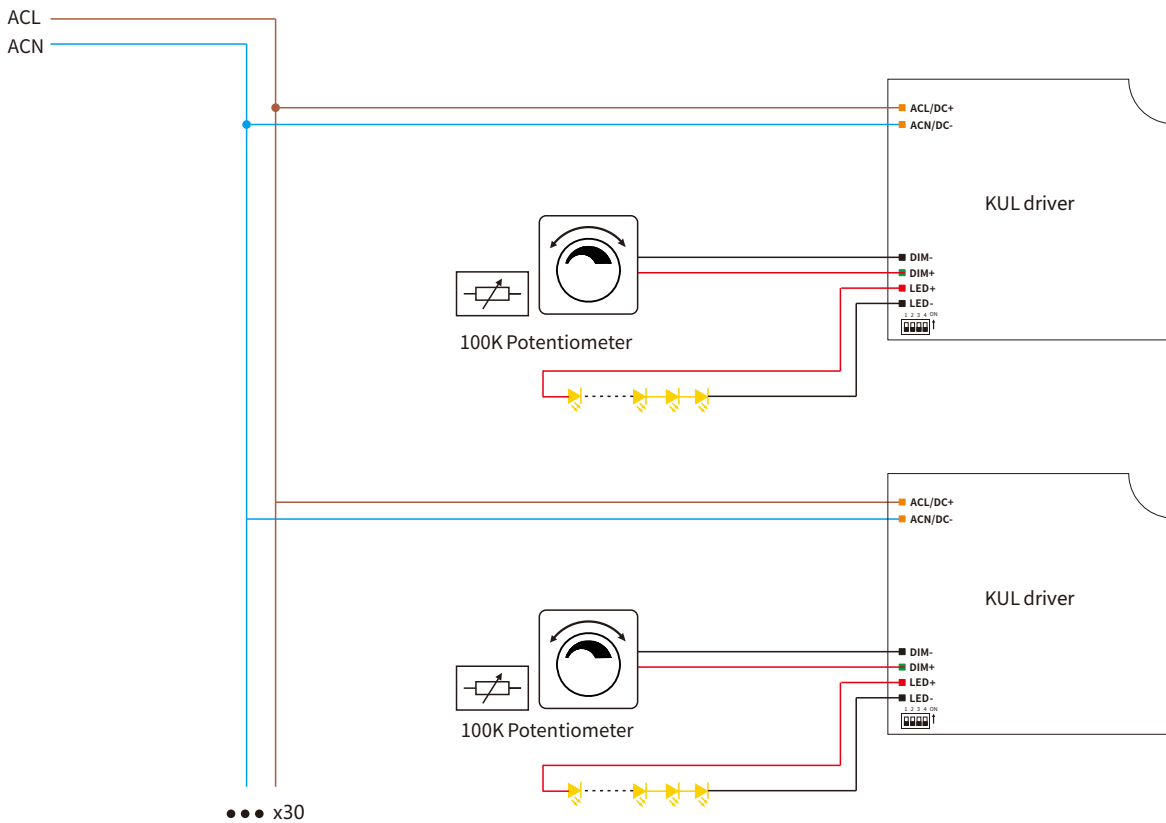

### Remarks

- In the 100K potentiometer dimming mode, the potentiometer can only be connected to one driver.

### Dimming curve

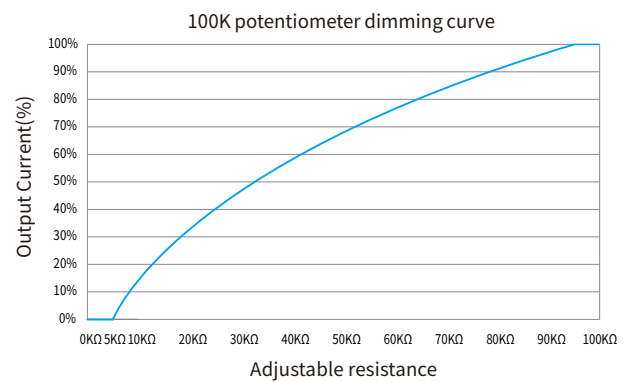

**Installation**

**Mechanical dimensions**

Unit:mm

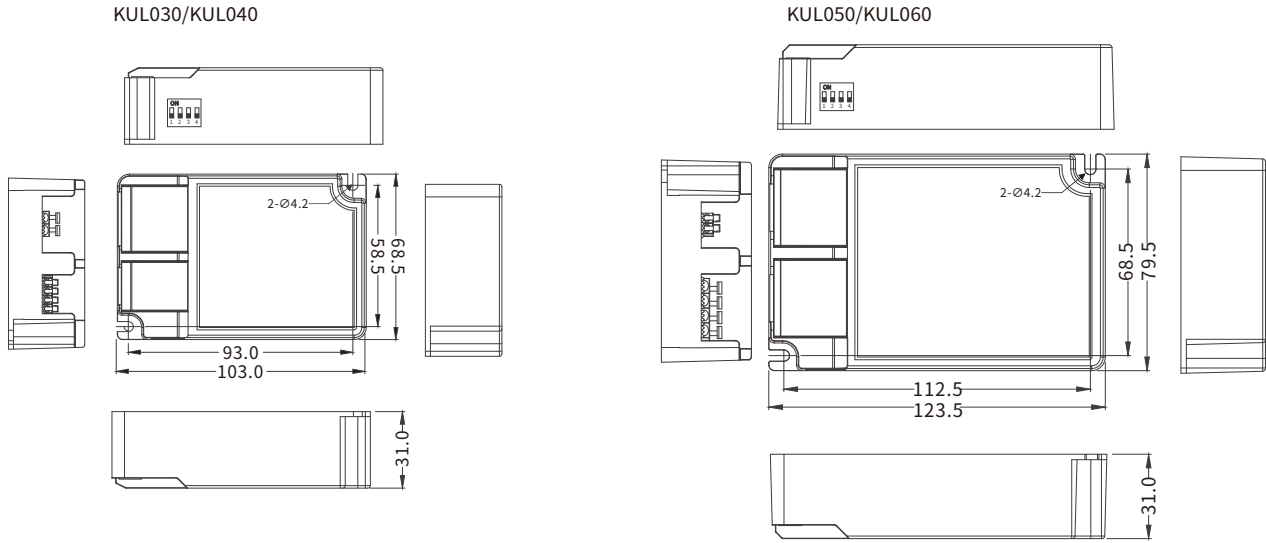

**INPUT**

Numbering	function	colour
1	ACL/DC+	orange
2	ACN/DC-	orange

**Input wire**

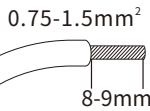

**OUTPUT**

Numbering	function	colour
1	DIM-	black
2	DIM+	green
3	LED+	red
4	LED-	black

**Output wire**

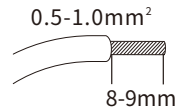

**Installation note**

**Hot plug-in**

- Hot plug-in is not supported due to residual output voltage of > 0 V.

**Wiring guidelines**

- All connections must be kept as short as possible to ensure good EMI behaviour.
- Mains leads should be kept apart from LED Driver and other leads (ideally 5 – 10 cm distance)
- Max. length of output wires is 2 m.
- Incorrect wiring can damage LED modules.

**Installation requirements**

- The driver should be installed in a dry, acid-free, oil-free, fat-free environment.
- The installation ambient temperature of the drive shall not exceed the value of Ta at any time.
- The temperature of the mounting surface of the driver should be lower than 40°C
- The driver should keep a certain distance from the heating stuff (such as the luminaire radiator).
- If the driver is used externally (it needs to be used with the accessories), the installation of the driver should also meet the following conditions:
  - 1.The driver should be a certain distance between the drivers, as shown in Figure 1.
  - 2.The driver keeps a certain distance from surrounding objects, as shown in Figure 2.

**Mounting screw specifications and torque**

- Max. torque at the clamping screw: 0.5 Nm / M4

**Replace LED module**

1. Mains off
2. Remove LED module
3. Wait for 5 seconds
4. Connect LED module again

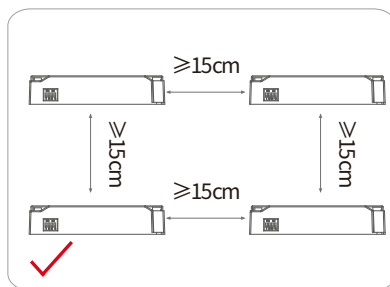
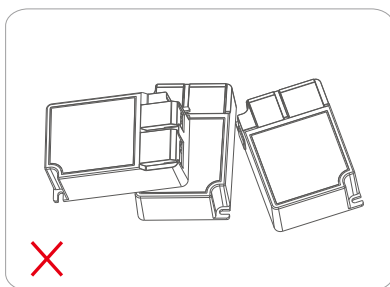

Figure 1

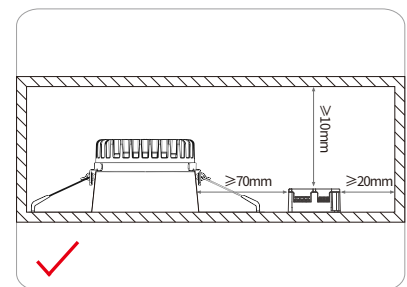
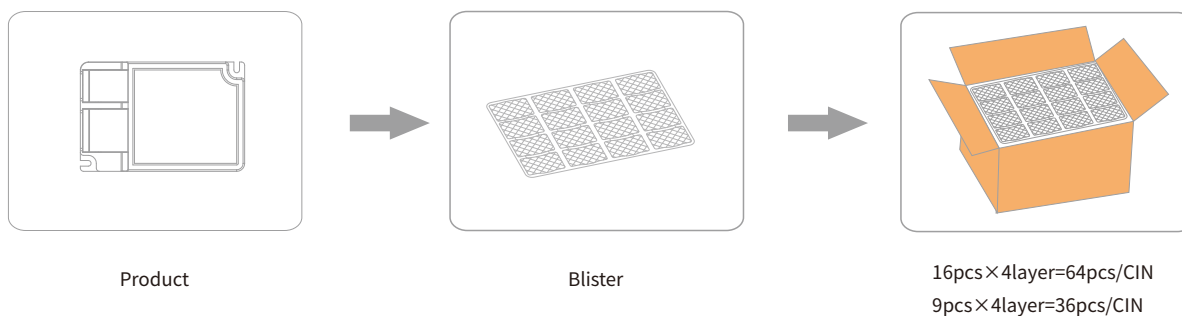

Figure 2

## Packaging

### Optional 1: factory default



Model	Product size	Weight	Blister size	Carton size	Qty/carton	N.W	G.W
KUL030	L103*W68.5*H31mm	140g	L480*W330*H40mm	L490*W340*H165mm	64pcs	8.96kg	10.5kg
KUL040	L103*W68.5*H31mm	140g	L480*W330*H40mm	L490*W340*H165mm	64pcs	8.96kg	10.5kg
KUL050	L123*W78.5*H31mm	195g	L435*W345*H40mm	L450*W350*H180mm	36pcs	7.02kg	8.62kg
KUL060	L123*W78.5*H31mm	216g	L435*W345*H40mm	L450*W350*H180mm	36pcs	7.78kg	8.99kg

### Optional 2:



Model	Product size	Weight	Packaging size	Carton size	Qty/carton	N.W	G.W
KUL030	L103*W68.5*H31mm	140g	L130*W38*H85mm	L415*W330*H190mm	48pcs	6.72kg	8.7kg
KUL040	L103*W68.5*H31mm	140g	L130*W38*H85mm	L415*W330*H190mm	48pcs	6.72kg	8.7kg
KUL050	L123*W78.5*H31mm	195g	L140*W40*H100mm	L380*W295*H220mm	36pcs	7.02kg	9.0kg
KUL060	L123*W78.5*H31mm	216g	L140*W40*H100mm	L380*W295*H220mm	36pcs	7.78kg	9.72kg

### Additional information

1. This product can only be used outside the light body, Can not be used inside of the light, and it must be used within the specified working environment.
2. The life and MTBF of the product are for reference only, and do not represent a warranty statement.
3. For more information, please send an email to [info@bokedriver.com](mailto:info@bokedriver.com).