

Constant current independent dimmable driver
PUL-A Series suffix M(1-10V/10V PWM)



Features

- Support 1-10V/10V PWM dimming mode
- 10-level current output can be realized by DIP-switch
- Soft dimming and flicker-free at any brightness
- Using HPC patented technology at any dimming level, the brightness between lights is same
- Dimming range 1~100%, output current accuracy 1%
- Standby power input<0.5W, meets the requirements of ErP certification
- High PF, high efficiency, low THD
- Screw-free and pressing type strain relief, supports thicker cables and is easier to install
- Independent input and output strain relief, stronger wiring
- SELV and Class II design, suitable for use outside of the light
- Passed ENEC-TUV,CE,RCM,CCC and other certifications
- IP20 protection grade, indoor use
- Nominal life-time up to 100,000 h
- 5-year guarantee

Interfaces

- DIM(1-10V / 10V PWM)

Functions

- Support central emergency application (dimming normal in DC input)
- Support self-contained emergency application
- Protective features (short-circuit,no-load protection)

Suitable for lights

- Suitable for lights with independent drivers such as downlights, spotlights, panel lights, etc
- Not suitable for lights with built-in drivers

Typical applications

- LED indoor lighting
- LED office lighting
- LED commercial lighting



Model coding rules of PUL-A series

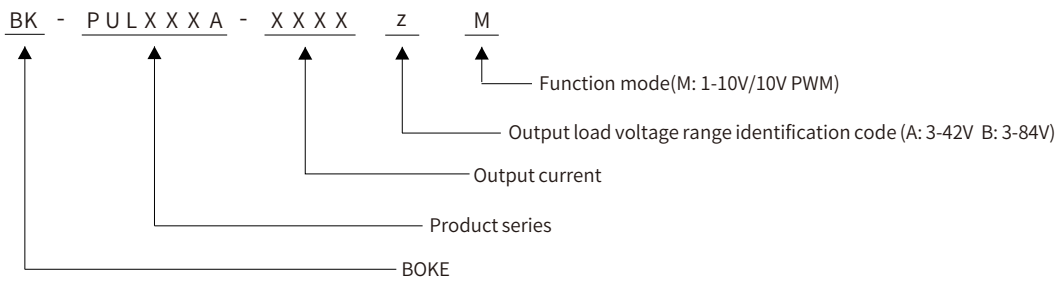

Optional dimming function selection table of PUL-A series

Model	Suffix	Wired dimming		
		DALI-2	PUSH	1-10V 2in1
PUL030A	D	√	√	√
	d	√	√	
	P		√	√
PUL042A	P		√	√
PUL060A	M			√
PUL010A	d	√		
PUL018A	P		√	
PUL010B	M			√
PUL018B				

* The description in this specification is only applicable to the products with the suffix M and the model are PUL030A and PUL042A and PUL060A.

Order selection table of PUL-A series(just suffix M, 30W/42W/60W)

Model	Input voltage	Output power	Output voltage	Output current	Dimension	Article number
BK-PUL030A-0700AM	200-240VAC	29.4W	3-42VDC	0.25-0.70A	L103*W68*H30mm	B-PUL030A-HF001
BK-PUL042A-0700BM	200-240VAC	42.0W	3-84VDC	0.25-0.70A	L103*W68*H30mm	B-PUL042A-HF013
BK-PUL042A-1100AM	200-240VAC	42.0W	3-42VDC	0.60-1.10A	L123*W79*H31mm	B-PUL042A-HF014
BK-PUL060A-2000AM	200-240VAC	61.2W	3-42VDC	0.80-2.00A	L123*W79*H31mm	B-PUL060A-HF006

Technical data

Product model	BK-PUL030A-0700AM
Output parameters	
Regulation method	Constant Current
Rated output current	0.25-0.7A
Rated output voltage	3-42V
Rated output power	29.4W Max
Output current adjustment	DIP S.W(10 levels)
Output current ripple LF	±1%
Output current accuracy	±2%
Linear regulation	±1%
Load regulation	±1%
No load output voltage	50V
Flicker-free(typical)	Modulation depth =0.106% (100 Hz), Pst LM ≤ 0.000, SVM ≤ 0.003,(The above parameters are obtained from testing the panel lights)
Input parameters	
Rated input voltage	200-240VAC 200-240VDC
Rated input voltage	180-264VAC 180-264VDC
Input voltage shock	<380V AC, 1 h
Input current	<0.2A (AC input)
Input frequency	47-63Hz
Input power factor	>0.95 (230V AC & Full load)
Input THD	<10% (230V AC & Full load)
Efficiency(typical)	87% (230V AC & Full load)
In-rush current	4.33A peak, 164us duration(50% Ipeak), see the description below for details
Start/Switchover/Turn off	<0.6s(AC start), <0.6s(DC start), <0.3s(AC/DC switchover), <0.5s(Turn off)
Switching cycles	> 50,000 switching cycles
Power consumption	Full load(Pmax):29.4W, No load(Pno): N/A, On stand-by(Psb) : <0.5W, Network stand-by(Pnet) : N/A
Safety	
Withstand voltage	I/P-O/P:3750V AC
Mains surge capability	L-N:2KV
Leakage current	<0.7mA (230V AC & Full load)
Isolation resistance	I/P-O/P:100MΩ/500Vdc/25°C/70% RH
Control interface	
DALI dimming port	N/A
PUSH dimming port	N/A
1-10V 2in1 dimming port	Voltage range: 0-10V, interface current consumption: 0.3mA
Auxiliary power supply	N/A
Dimming range	1-100%
Dimming drive mode	AM(amplitude modulation)
Emergency support	
Central emergency system	Supported(Under DC input conditions)
Self-contained emergency	Supported
Environment & Life time	
Operating temperature	Ta=-20-45°C
Case temperature	Tc=75°C
Operating humidity	5-85% RH, not condensed
Storage temp./humidity	-40-80°C, 5-85% RH, not condensed
IP grade	IP20
MTBF	500,000H,MIL-HDBK-217F(25°C)
Life-time	Nominal life-time up to 100,000 h, see the description below for details
Vibration resistant	10~500Hz,5G 12min./1cycle,period for 72min. each along X,Y,Z axes
Acoustic Noise	<25dB(30cm, Full load)
Environmental protection	RoHS
Certifications and standards	
Certified	ENEC-TUV, RCM, EMC, CE, CCC
Safety	EN61347-1, EN61347-2-13, EN62384
EMC	EN55015, EN61000-3-2, EN61000-3-3, EN61000-4-2,3,4,5,6,8,11, EN61547
DALI-2	N/A
EL	Compatible IEC 61347-2- 13 Annex J, compatible with EN 60598-2-22 and EN 50172
RF	N/A

Remarks

- 1.By default, all parameter are measured at 230VAC input, full load and 25°C of ambient temperature.
- 2.The driver can not be installed inside the light. when the driver is used with the light, the EMC of the whole light needs to be tested.

Technical data

Product model	BK-PUL042A-0700BM	BK-PUL042A-1100AM	
Output parameters			
Regulation method	Constant Current	Constant Current	
Rated output current	0.25-0.7A	0.6-1.1A	
Rated output voltage	3-84V	3-42V	
Rated output power	42W Max	42W Max	
Output current adjustment	DIP S.W(10 levels)	DIP S.W(10 levels)	
Output current ripple LF	±1%	±1%	
Output current accuracy	±2%	±2%	
Linear regulation	±1%	±1%	
Load regulation	±1%	±1%	
No load output voltage	100V	50V	
Flicker-free(typical)	Modulation depth =0.440% (100 Hz), Pst LM ≤ 0.003, SVM ≤ 0.007,(The above parameters are obtained from testing the panel lights)		
Input parameters			
Rated input voltage	200-240VAC 200-240VDC		
Rated input voltage	180-264VAC 180-264VDC		
Input voltage shock	<380V AC, 1 h		
Input current	<0.3A (AC input)		
Input frequency	47-63Hz		
Input power factor	>0.95 (230V AC & Full load)		
Input THD	<10% (230V AC & Full load)		
Efficiency(typical)	88% (230V AC & Full load)		
In-rush current	4.88A peak ,154us duration(50 % Ipeak), see the description below for details		
Start/Switchover/Turn off	<0.6s(AC start),<0.6s(DC start),<0.3s(AC/DC switchover),<0.5s(Turn off)		
Switching cycles	> 50,000 switching cycles		
Power consumption	Full load(Pmax):42W, No load(Pno): N/A, On stand-by(Psb) : <0.5W, Network stand-by(Pnet) : N/A		
Safety			
Withstand voltage	I/P-O/P:3750V AC		
Mains surge capability	L-N:2KV		
Leakage current	<0.7mA (230V AC & Full load)		
Isolation resistance	I/P-O/P:100MΩ/500Vdc/25°C/70% RH		
Control interface			
DALI dimming port	N/A		
PUSH dimming port	N/A		
1-10V 2in1 dimming port	Voltage range: 0-10V, interface current consumption: 0.3mA		
Auxiliary power supply	N/A		
Dimming range	1-100%		
Dimming drive mode	AM(amplitude modulation)		
Emergency support			
Central emergency system	Supported(Under DC input conditions)		
Self-contained emergency	Supported		
Environment & Life time			
Operating temperature	Ta=-20-45°C		
Case temperature	Tc=75°C		
Operating humidity	5-85% RH, not condensed		
Storage temp./humidity	-40-80°C, 5-85% RH, not condensed		
IP grade	IP20		
MTBF	500,000H,MIL-HDBK-217F(25°C)		
Life-time	Nominal life-time up to 100,000 h, see the description below for details		
Vibration resistant	10~500Hz,5G 12min./1cycle,period for 72min. each along X,Y,Z axes		
Acoustic Noise	<25dB(30cm, Full load)		
Environmental protection	RoHS		
Certifications and standards			
Certified	ENEC-TUV, RCM, EMC, CE, CCC		
Safety	EN61347-1, EN61347-2-13, EN62384		
EMC	EN55015, EN61000-3-2 , EN61000-3-3, EN61000-4-2,3,4,5,6,8,11, EN61547		
DALI-2	N/A		
EL	Compatible IEC 61347-2- 13 Annex J, compatible with EN 60598-2-22 and EN 50172		
RF	N/A		

Remarks

- 1.By default, all parameter are measured at 230VAC input, full load and 25°C of ambient temperature.
- 2.The driver can not be installed inside the light. when the driver is used with the light, the EMC of the whole light needs to be tested.

Technical data

Product model	BK-PUL060A-2000AM
Output parameters	
Regulation method	Constant Current
Rated output current	0.8-2.0A
Rated output voltage	3-42V
Rated output power	61.2W Max
Output current adjustment	DIP S.W(10 levels)
Output current ripple LF	±1%
Output current accuracy	±2%
Linear regulation	±1%
Load regulation	±1%
No load output voltage	50V
Flicker-free(typical)	Modulation depth =0.183% (100 Hz), Pst LM ≤ 0.002, SVM ≤ 0.006,(The above parameters are obtained from testing the panel lights)
Input parameters	
Rated input voltage	200-240VAC 200-240VDC
Rated input voltage	180-264VAC 180-264VDC
Input voltage shock	<380 V AC, 1 h
Input current	<0.4A (AC input)
Input frequency	47-63Hz
Input power factor	>0.95 (230V AC & Full load)
Input THD	<10% (230V AC & Full load)
Efficiency(typical)	90% (230V AC & Full load)
In-rush current	9.51A peak ,178us duration(50 % Ipeak), see the description below for details
Start/Switchover/Turn off	<0.6s(AC start),<0.6s(DC start),<0.3s(AC/DC switchover),<0.5s(Turn off)
Switching cycles	> 50,000 switching cycles
Power consumption	Full load(Pmax):61.2W, No load(Pno): N/A, On stand-by(Psb) : <0.5W, Network stand-by(Pnet) : N/A
Safety	
Withstand voltage	I/P-O/P:3750V AC
Mains surge capability	L-N:2KV
Leakage current	<0.7mA (230V AC & Full load)
Isolation resistance	I/P-O/P:100MΩ/500Vdc/25°C/70% RH
Control interface	
DALI dimming port	N/A
PUSH dimming port	N/A
1-10V 2in1 dimming port	Voltage range: 0-10V, interface current consumption: 0.3mA
Auxiliary power supply	N/A
Dimming range	1-100%
Dimming drive mode	AM(amplitude modulation)
Emergency support	
Central emergency system	Supported(Under DC input conditions)
Self-contained emergency	Supported
Environment & Life time	
Operating temperature	Ta=-20-45°C
Case temperature	Tc=80°C
Operating humidity	5-85% RH, not condensed
Storage temp./humidity	-40-80°C, 5-85% RH, not condensed
IP grade	IP20
MTBF	500,000H,MIL-HDBK-217F(25°C)
Life-time	Nominal life-time up to 100,000 h, see the description below for details
Vibration resistant	10~500Hz,5G 12min./1cycle,period for 72min. each along X,Y,Z axes
Acoustic Noise	<25dB(30cm, Full load)
Environmental protection	RoHS
Certifications and standards	
Certified	ENEC-TUV, RCM, EMC, CE, CCC
Safety	EN61347-1, EN61347-2-13, EN62384
EMC	EN55015, EN61000-3-2 , EN61000-3-3, EN61000-4-2,3,4,5,6,8,11, EN61547
DALI-2	N/A
EL	Compatible IEC 61347-2- 13 Annex J, compatible with EN 60598-2-22 and EN 50172
RF	N/A

Remarks

- 1.By default, all parameter are measured at 230VAC input, full load and 25°C of ambient temperature.
- 2.The driver can not be installed inside the light. when the driver is used with the light, the EMC of the whole light needs to be tested.

Electrical values

BK-PUL030A-0700AM

Operating window

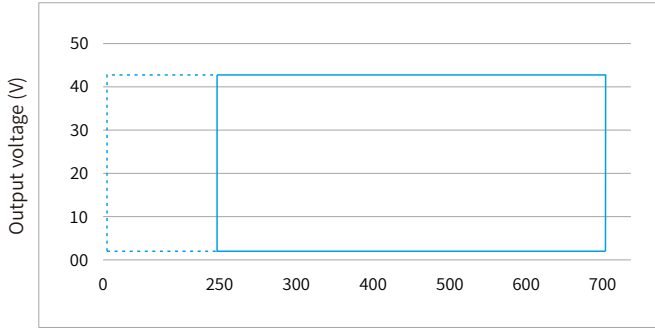

Output current(mA) — Operating window 100 %
 Operating window dimmed

Operating window

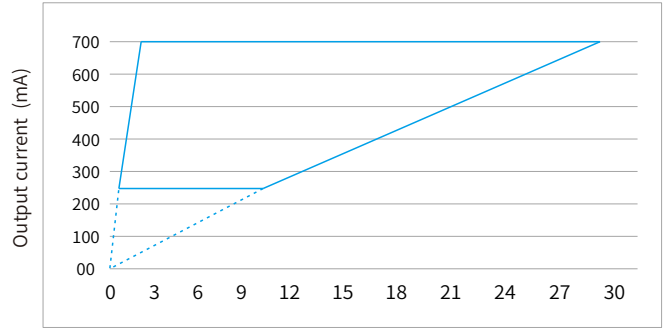

Output power(W) — Operating window 100 %
 Operating window dimmed

Efficiency vs load

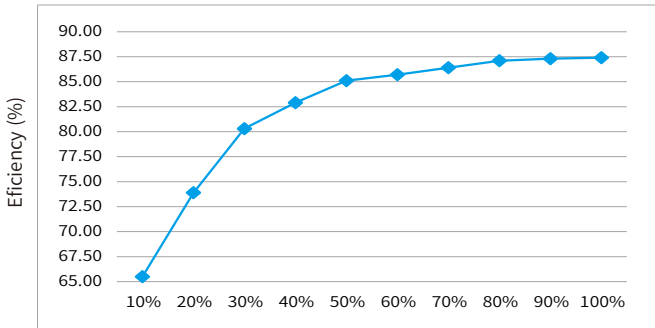

Load(%)

THD vs. Load

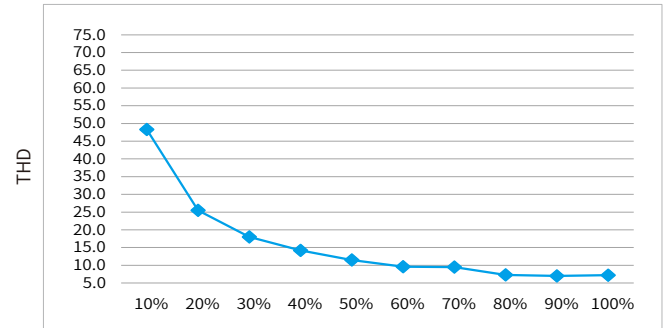

Load(%)

Power factor vs. Load

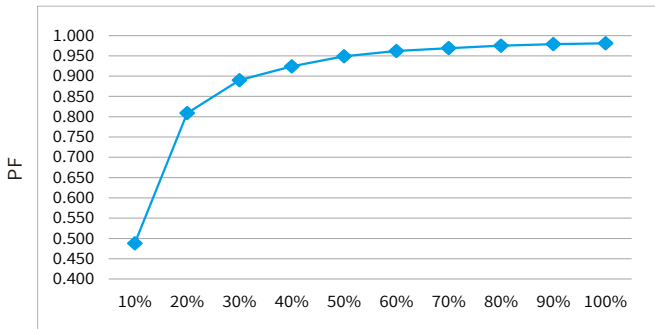

Load(%)

BK-PUL042A-0700BM

Operating window

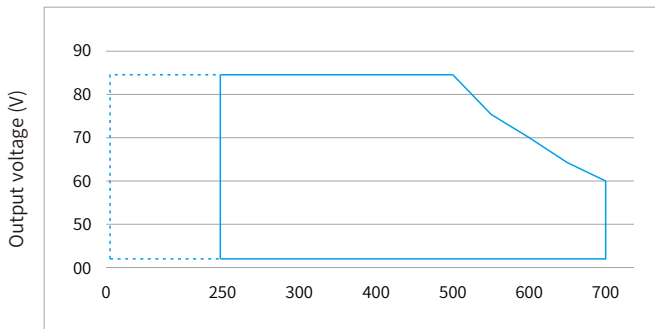

Output current(mA) — Operating window 100 %
 Operating window dimmed

Operating window

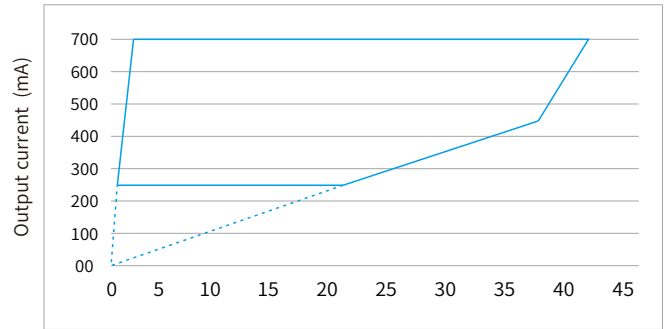

Output power(W) — Operating window 100 %
 Operating window dimmed

BK-PUL042A-0700BM (Continue)

Efficiency vs load

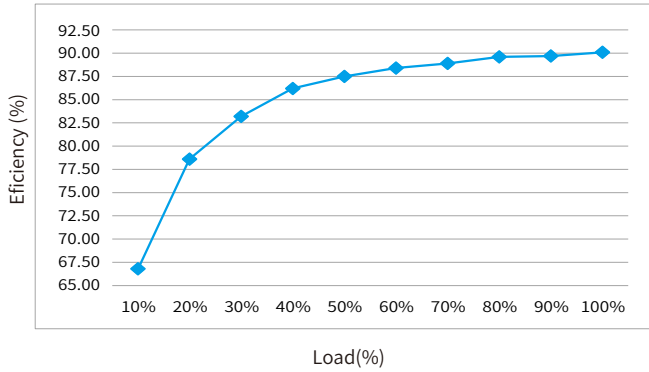

THD vs. Load

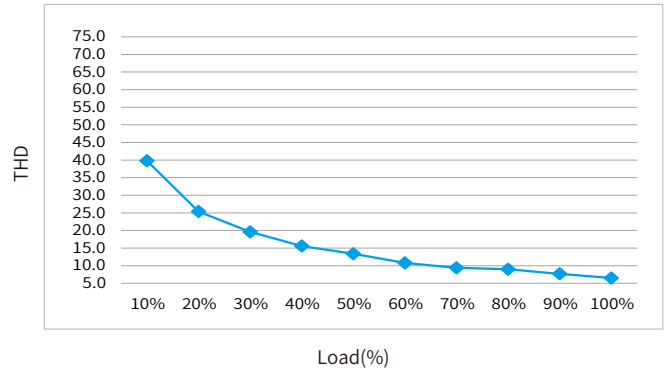

Power factor vs. Load

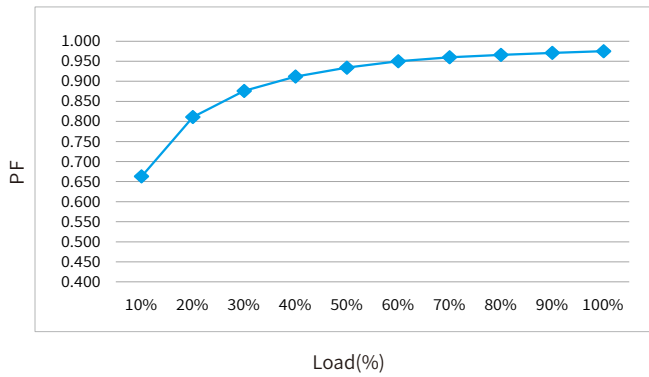

BK-PUL042A-1100AM

Operating window

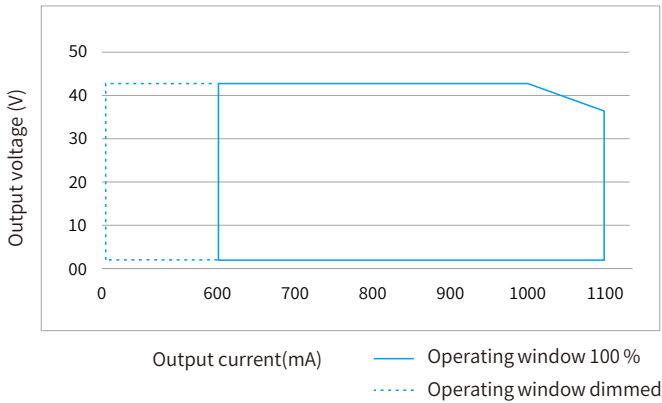

Operating window

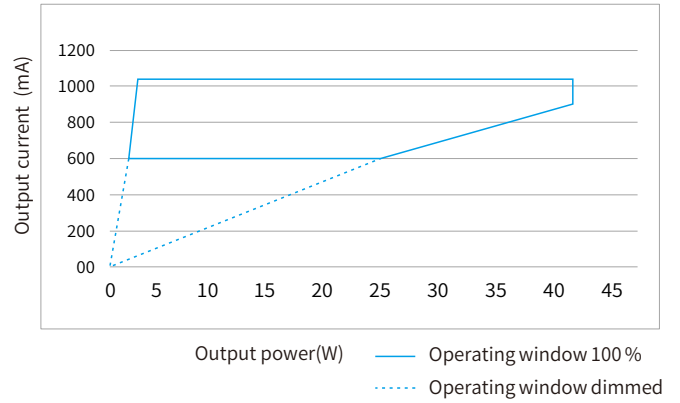

Efficiency vs load

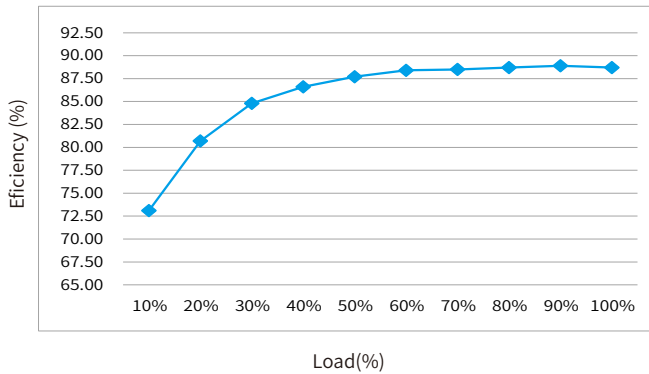

THD vs. Load

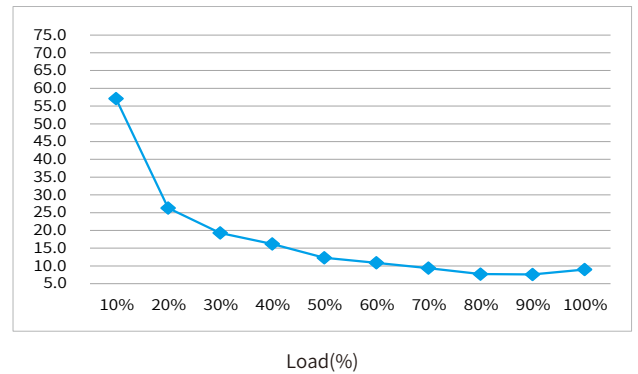

BK-PUL042A-1100AM (Continue)

Power factor vs. Load

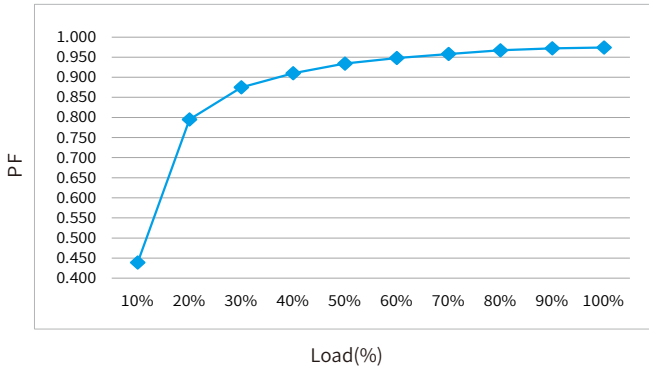

BK-PUL060A-2000AM

Operating window

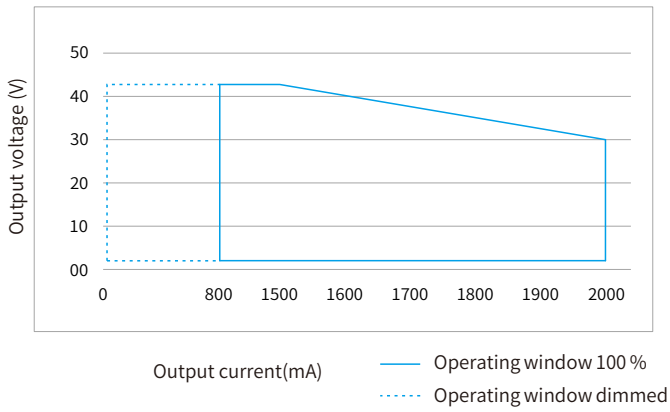

Operating window

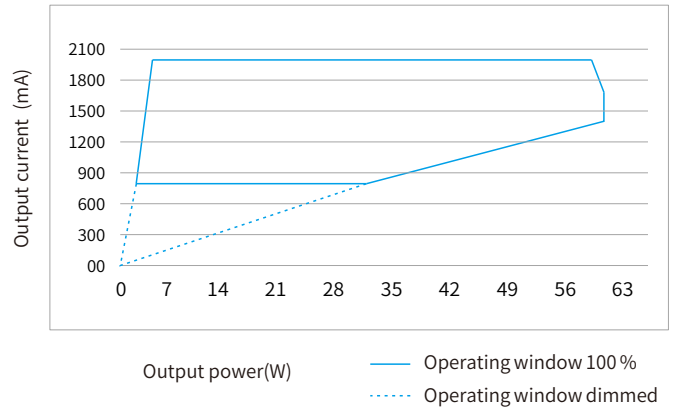

Efficiency vs load

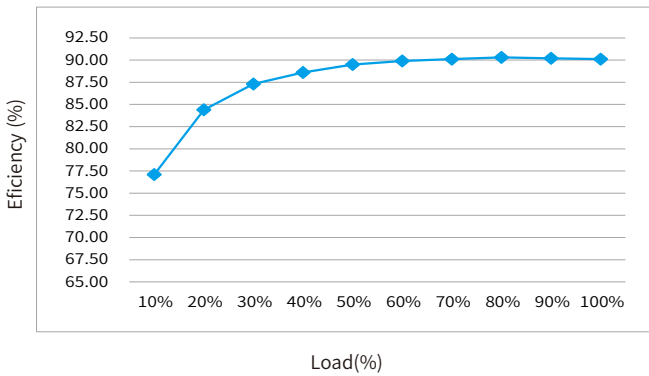

THD vs. Load

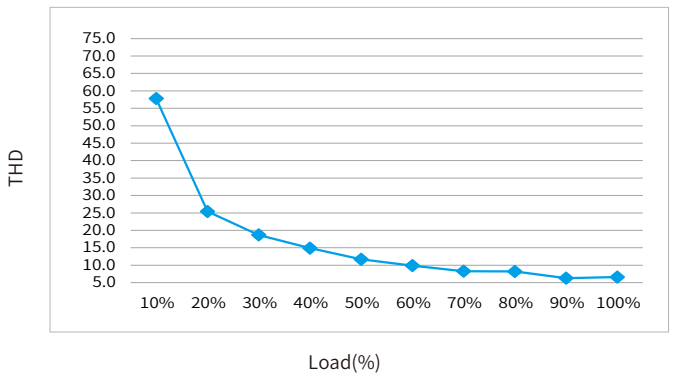

Power factor vs. Load

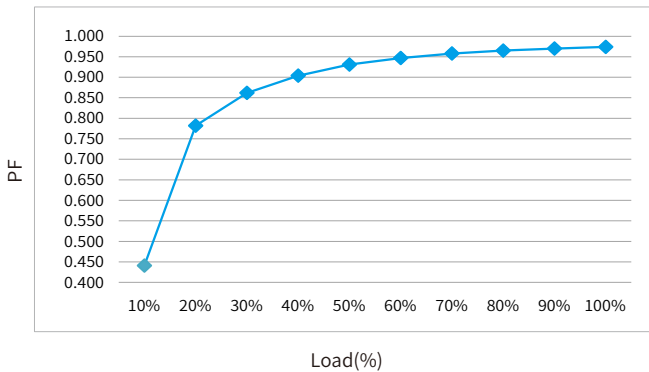

Expected life-time

BK-PUL030A-0700AM

Life-time vs. case temperature

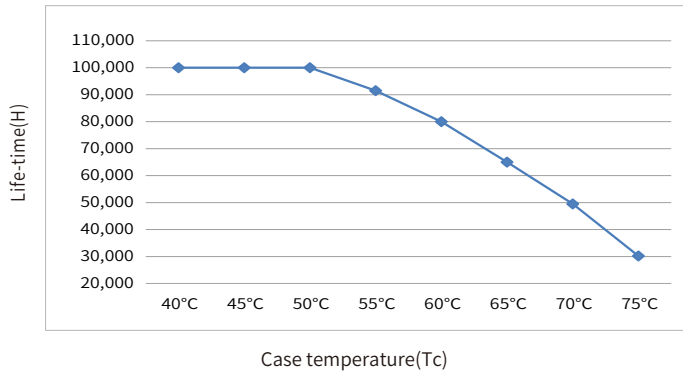

BK-PUL042A-0700BM

Life-time vs. case temperature

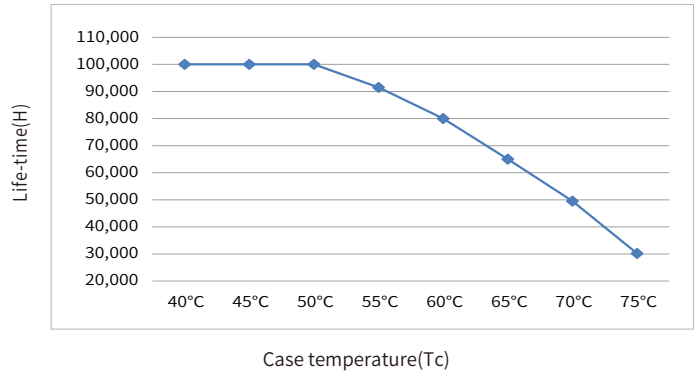

BK-PUL042A-1100AM

Life-time vs. case temperature

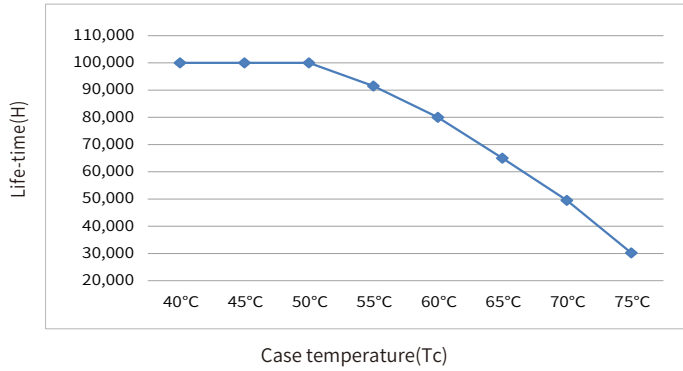

BK-PUL060A-2000AM

Life-time vs. case temperature

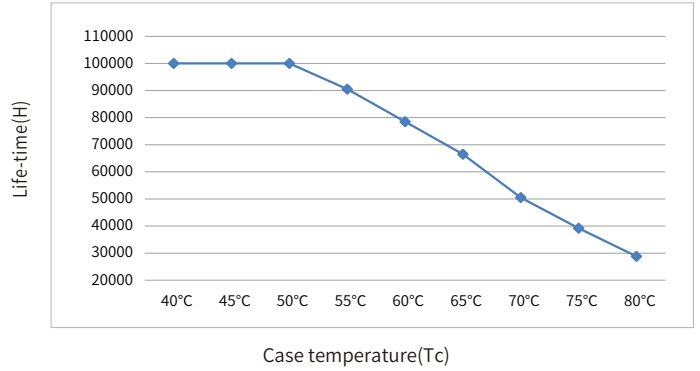

- The life-time of the LED driver is shown in the figure above (calculated based on the 90% survival rate).
- The relation of tc to ta temperature depends also on the luminaire design.

Surge

Model	Ipeak	Twidth	Condition	Relative number of MCB															
				B10	B13	B16	B20	B25	C10	C13	C16	C20	C25	D10	D13	D16	D20	D25	
BK-PUL030A-0700AM	4.33A	164us	AC 230V, Full load, Cold start, $T_a \leq 30^\circ\text{C}$, MCB is not installed side by side	46	60	74	92	116	46	60	74	92	116	46	60	74	92	116	
BK-PUL042A-1100AM	4.88A	154us		33	43	52	65	82	33	43	52	65	82	33	43	52	65	82	
BK-PUL060A-2000AM	9.51A	178us		23	30	37	46	57	23	30	37	46	57	23	30	37	46	57	

Remarks

- The number of drives mounted under different MCBs in the table is the maximum value. Please do not exceed this number during installation.
- Calculation uses typical values from ABB series S200 as a reference.
- Different brands and models of miniature circuit breakers, the number of drives mounted will be slightly different.
- If the ambient temperature of the MCB installation exceeds 30°C or multiple MCBs are installed side by side, the number of drives mounted will be reduced and the calculation needs to be recalculated.
- Electrician's usually consider Type B for household lighting and Type C for commercial lighting application.

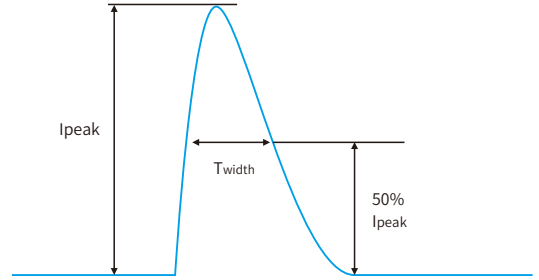

Functions

Output short-circuit behaviour

- In case of a short-circuit at the LED output ,the LED output is switched off.
- After restart of the LED driver ,the output will be activated again.
- The restart can either be done via mains reset or via interface (1-10V).

Output no-load operation

- The LED driver will not be damaged in no-load operation.
- The output will be deactivated and is therefore free of voltage.
- If a LED load is connected the device has to be restarted before the output will be activated again.
- The restart can either be done via mains reset or via interface (1-10V).

DIP-switch & output current

Label

BK-PUL030A-0700AM

Pin	Irated	Voltage	1	2	3	4
12.7W	250mA	42VDC	--	ON	ON	ON
14.9W	300mA	42VDC	ON	--	ON	ON
17.4W	350mA	42VDC	--	--	ON	ON
19.5W	400mA	42VDC	--	ON	--	ON
21.9W	450mA	42VDC	--	--	--	ON
24.3W	500mA	42VDC	ON	ON	ON	--
26.5W	550mA	42VDC	--	--	ON	--
28.9W	600mA	42VDC	--	ON	--	--
31.3W	650mA	42VDC	ON	--	--	--
33.7W	700mA	★ 42VDC	--	--	--	--

BOKE Dimmable Constant Current LED Driver
MODEL: BK-PUL030A-0700AM
 INPUT: 200-240V~ 50/60Hz 0.2A Max λ = 0.95
 OUTPUT: 50V == Max. other ratings see below sheet

Switching selection sheet

Pin	Irated	Output Voltage	Prated	1	2	3	4
12.7W	250mA	3-42VDC	10.5W	ON	ON	ON	ON
14.9W	300mA	3-42VDC	12.6W	ON	ON	ON	ON
17.4W	350mA	3-42VDC	14.7W	ON	ON	ON	ON
19.5W	400mA	3-42VDC	16.8W	ON	ON	ON	ON
21.9W	450mA	3-42VDC	18.9W	ON	ON	ON	ON
24.3W	500mA	3-42VDC	21.0W	ON	ON	ON	ON
26.5W	550mA	3-42VDC	23.1W	ON	ON	ON	ON
28.9W	600mA	3-42VDC	25.2W	ON	ON	ON	ON
31.3W	650mA	3-42VDC	27.3W	ON	ON	ON	ON
33.7W	700mA	3-42VDC	29.4W	ON	ON	ON	ON

Before use, always check dipswitch settings!

•tc
 tc=75°C
 ta=45°C

MADE IN CHINA

LED -
 LED +
 DIM -
 DIM +

APPROVALS: ENEC, TUV SUD, SAA, RoHS SELV

For LED Modules use only

SEC wire prep. 0.5-1.5mm² φ
 PRI wire prep. 0.75mm² φ

BK-PUL042A-0700BM

Pin	Irated	Voltage	1	2	3	4
23W	250mA	84VDC	--	ON	ON	ON
28W	300mA	84VDC	ON	--	ON	ON
32W	350mA	84VDC	--	--	ON	ON
37W	400mA	84VDC	--	ON	--	ON
41W	450mA	84VDC	--	--	--	ON
46W	500mA	84VDC	ON	ON	ON	--
46W	550mA	76VDC	--	--	ON	--
46W	600mA	70VDC	--	ON	--	--
46W	650mA	64VDC	ON	--	--	--
47W	700mA	★ 60VDC	--	--	--	--

BOKE Dimmable Constant Current LED Driver
MODEL: BK-PUL042A-0700BM
 INPUT: 200-240V~ 50/60Hz 0.3A Max λ = 0.95
 OUTPUT: 100V == Max. other ratings see below sheet

Switching selection sheet

Pin	Irated	Output Voltage	Prated	1	2	3	4
24W	250mA	3-84VDC	21W	ON	ON	ON	ON
29W	300mA	3-84VDC	25.2W	ON	ON	ON	ON
33W	350mA	3-84VDC	29.4W	ON	ON	ON	ON
38W	400mA	3-84VDC	33.6W	ON	ON	ON	ON
42W	450mA	3-84VDC	37.8W	ON	ON	ON	ON
47W	500mA	3-84VDC	42W	ON	ON	ON	ON
47W	550mA	3-76VDC	41.8W	ON	ON	ON	ON
47W	600mA	3-70VDC	42W	ON	ON	ON	ON
47W	650mA	3-64VDC	41.6W	ON	ON	ON	ON
48W	700mA	3-60VDC	42W	ON	ON	ON	ON

Before use, always check dipswitch settings!

•tc
 tc=75°C
 ta=45°C

MADE IN CHINA

LED -
 LED +
 DIM -
 DIM +

APPROVALS: ENEC, TUV SUD, SAA, RoHS SELV

For LED Modules use only

SEC wire prep. 0.5-1.5mm² φ
 PRI wire prep. 0.75mm² φ

BK-PUL042A-1100AM

Pin	Irated	Voltage	1	2	3	4
29W	600mA	42VDC	--	ON	ON	ON
34W	700mA	42VDC	ON	--	ON	ON
36W	750mA	42VDC	--	--	ON	ON
39W	800mA	42VDC	--	ON	--	ON
41W	850mA	42VDC	--	--	--	ON
43W	900mA	42VDC	ON	ON	ON	--
46W	950mA	42VDC	--	--	ON	--
48W	1000mA	42VDC	--	ON	--	--
48W	1050mA	40VDC	ON	--	--	--
48W	1100mA	★ 38VDC	--	--	--	--

BOKE Dimmable Constant Current LED Driver
MODEL: BK-PUL042A-1100AM
 INPUT: 200-240VAC~ 50/60Hz 0.3A Max λ = 0.95
 OUTPUT: 50V == Max. other ratings see below sheet

Switching selection sheet

Pin	Irated	Output Voltage	Prated	1	2	3	4
29W	600mA	3-42VDC	25.2W	ON	ON	ON	ON
34W	700mA	3-42VDC	29.4W	ON	ON	ON	ON
36W	750mA	3-42VDC	31.5W	ON	ON	ON	ON
39W	800mA	3-42VDC	33.6W	ON	ON	ON	ON
41W	850mA	3-42VDC	35.7W	ON	ON	ON	ON
43W	900mA	3-42VDC	37.8W	ON	ON	ON	ON
46W	950mA	3-42VDC	39.9W	ON	ON	ON	ON
48W	1000mA	3-42VDC	42W	ON	ON	ON	ON
48W	1050mA	3-40VDC	42W	ON	ON	ON	ON
48W	1100mA	3-38VDC	41.8W	ON	ON	ON	ON

Before use, always check dipswitch settings!

•tc
 tc=75°C
 ta=45°C

MADE IN CHINA

LED -
 LED +
 DIM -
 DIM +

APPROVALS: ENEC, TUV SUD, SAA, RoHS SELV

For LED Modules use only

SEC wire prep. 0.5-1.5mm² φ
 PRI wire prep. 0.75mm² φ

BK-PUL060A-2000AM

Pin	Irated	Voltage	1	2	3	4	5	6
38W	800mA	42VDC	ON	--	ON	--	ON	ON
43W	900mA	42VDC	--	--	--	--	--	ON
47W	1000mA	42VDC	ON	ON	ON	--	ON	--
52W	1100mA	42VDC	--	ON	ON	--	ON	--
54W	1150mA	42VDC	--	--	--	--	ON	--
59W	1250mA	42VDC	ON	--	ON	ON	--	--
61W	1300mA	42VDC	--	--	ON	ON	--	--
65W	1400mA	42VDC	--	ON	--	ON	--	--
68W	1500mA	40VDC	--	--	--	ON	--	--
69W	1600mA	38VDC	ON	ON	ON	--	--	--
69W	1700mA	36VDC	--	--	ON	--	--	--
69W	1800mA	34VDC	--	ON	--	--	--	--
69W	1900mA	32VDC	ON	--	--	--	--	--
69W	2000mA	★ 30VDC	--	--	--	--	--	--

BOKE Dimmable Constant Current LED Driver
MODEL: BK-PUL060A-2000AM
 INPUT: 200-240V~ 50/60Hz 0.4A Max λ = 0.95
 OUTPUT: 50V == Max. other ratings see below sheet

Switching selection sheet

Pin	Irated	Output Voltage	Prated	1	2	3	4	5	6
38W	800mA	3-42VDC	33.6W	ON	ON	ON	ON	ON	ON
43W	900mA	3-42VDC	37.8W	ON	ON	ON	ON	ON	ON
47W	1000mA	3-42VDC	42W	ON	ON	ON	ON	ON	ON
52W	1100mA	3-42VDC	46.2W	ON	ON	ON	ON	ON	ON
54W	1150mA	3-42VDC	48.3W	ON	ON	ON	ON	ON	ON
59W	1250mA	3-42VDC	52.5W	ON	ON	ON	ON	ON	ON
61W	1300mA	3-42VDC	54.6W	ON	ON	ON	ON	ON	ON
65W	1400mA	3-42VDC	58.8W	ON	ON	ON	ON	ON	ON
68W	1500mA	3-40VDC	60W	ON	ON	ON	ON	ON	ON
69W	1600mA	3-38VDC	60.8W	ON	ON	ON	ON	ON	ON
69W	1700mA	3-36VDC	61.2W	ON	ON	ON	ON	ON	ON
69W	1800mA	3-34VDC	61.2W	ON	ON	ON	ON	ON	ON
69W	1900mA	3-32VDC	60.8W	ON	ON	ON	ON	ON	ON
69W	2000mA	3-30VDC	60W	ON	ON	ON	ON	ON	ON

Before use, always check dipswitch settings!

•tc
 tc=80°C
 ta=45°C

MADE IN CHINA

LED -
 LED +
 DIM -
 DIM +

APPROVALS: ENEC, TUV SUD, SAA, RoHS SELV

For LED Modules use only

SEC wire prep. 0.5-1.5mm² φ
 PRI wire prep. 0.75mm² φ

Remarks:

- ★ It means that this item is the factory default current.
- It means that this channel is OFF.

1-10V/10V PWM dimming application

Wiring diagram

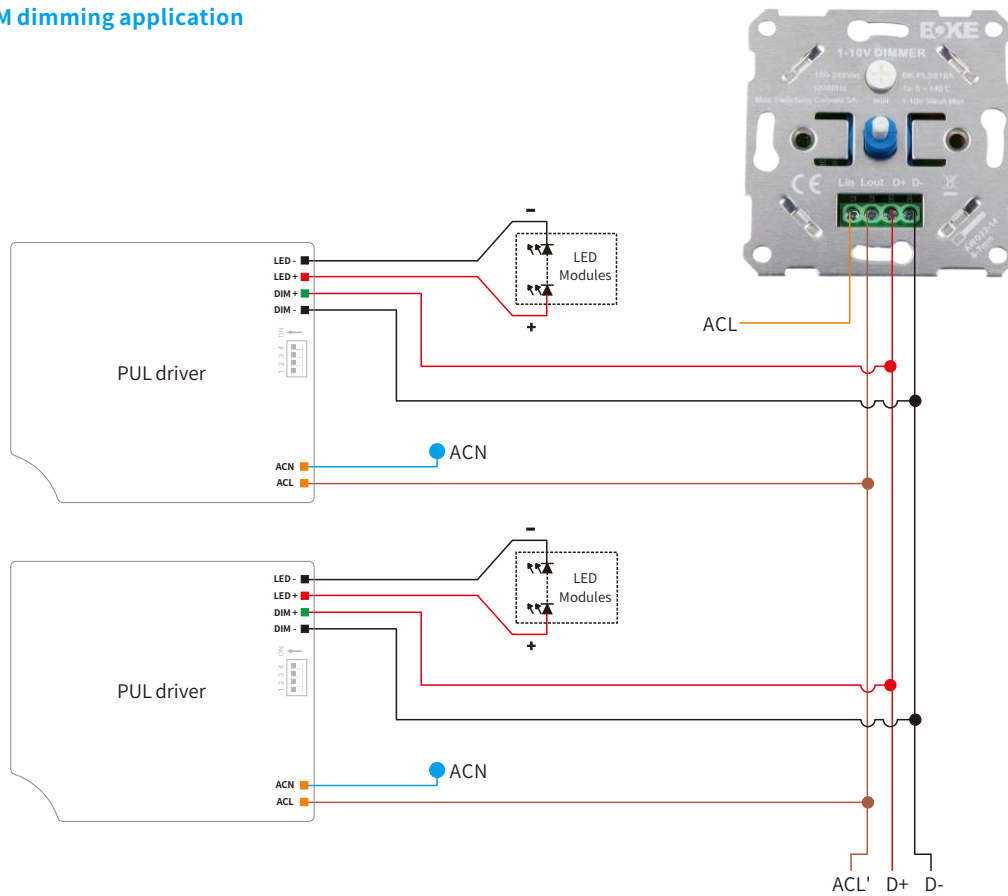

Remarks

- Dimming interface characteristics: 0.9V and below are closed, 1V is the darkest, 10V is the brightest, 1-10V is the dimming range.
- The dimming interface distinguishes between positive and negative, DIM+ is positive, DIM- is negative, please do not reverse.
- Dimming interface does not support voltage access higher than 20V, otherwise it will cause damage to the internal components.
- When the dimming interface is open, the driver outputs the maximum current. When the interface is short-circuited, the current output is closed.
- When multiple synchronous dimming is required, the positive poles of the dimming interface of each driver are connected together, and the negative poles are connected together.
- Support passive dimmer or isolated active dimmer dimming, does not support non-isolated active dimmer dimming.
- In general, it is recommended that the number of mounted drives does not exceed 30pcs, and the wiring length does not exceed 100m.
- It is recommended that the dimming wires should not be lower than the 22AWG wire.
- Do not put the dimming wires with high voltage or interference sources. If it is unavoidable, please use the shielded wires.
- If you need a drive with 0-10V dimming characteristics, please contact BOKE.

Dimming curve

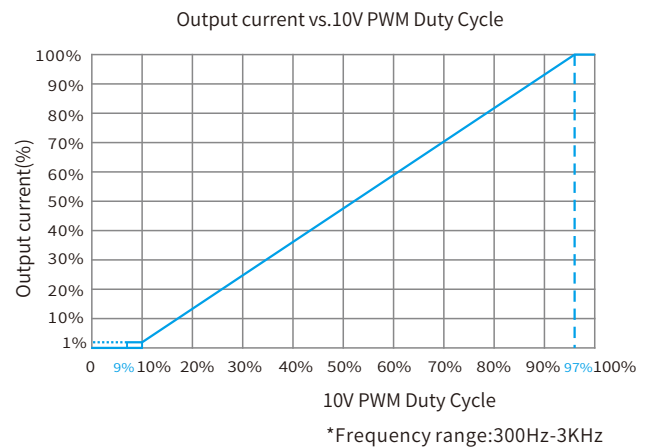
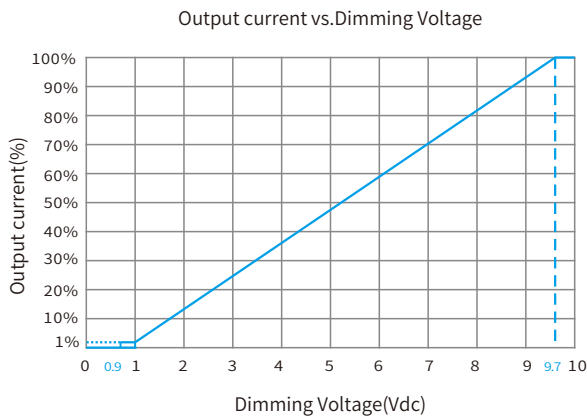

Installation

Mechanical dimensions

Unit:mm

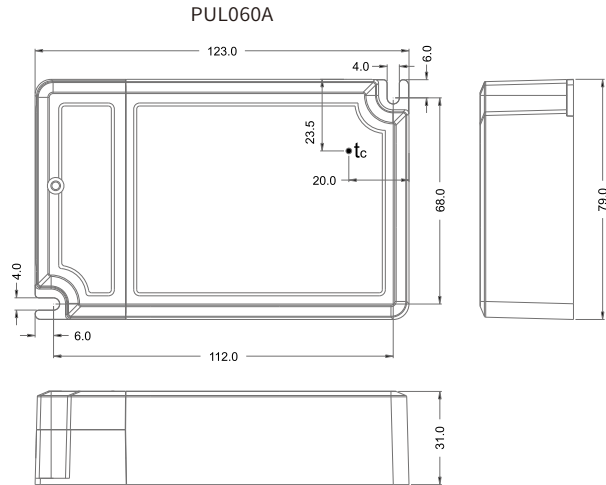
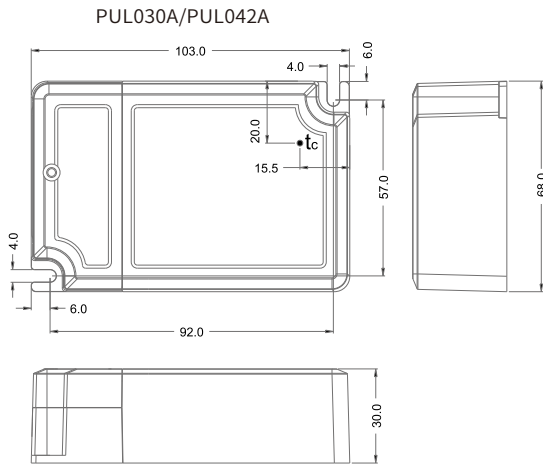

INPUT

Pin Numbering	function	colour
1	ACL	orange
2	ACN	orange

Input wire

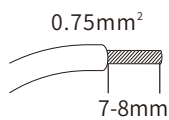

OUTPUT

Pin Numbering	function	colour
1	LED-	black
2	LED+	red
3	DIM+	green
4	DIM-	black

Output wire

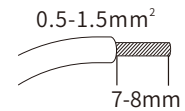

Installation note

Hot plug-in

- Hot plug-in is not supported due to residual output voltage of > 0 V.

Wiring guidelines

- All connections must be kept as short as possible to ensure good EMI behaviour.
- Mains leads should be kept apart from LED Driver and other leads (ideally 5 – 10 cm distance)
- Max. length of output wires is 2 m.
- Incorrect wiring can damage LED modules.

Mounting screw specifications and torque

- Max. torque at the clamping screw: 0.5 Nm / M4

Replace LED module

1. Mains off
2. Remove LED module
3. Wait for 5 seconds
4. Connect LED module again

Packaging

Optional 1: factory default

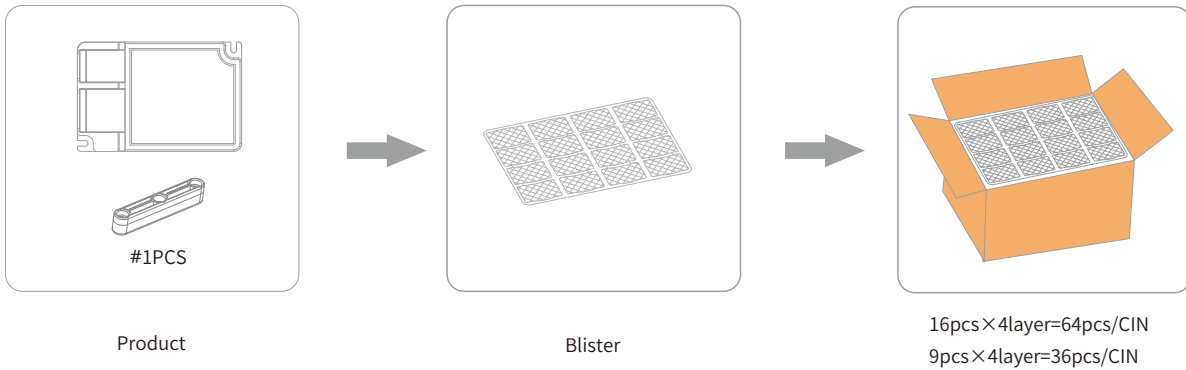

Model	Product size	Weight	Blister size	Carton size	Qty/carton	N.W	G.W
PUL030A	L103*W68*H30mm	140g	L480*W330*H40mm	L490*W340*H165mm	64 pcs	8.96kg	10.8kg
PUL042A	L103*W68*H30mm	168g	L480*W330*H40mm	L490*W340*H165mm	64 pcs	10.8kg	12.1kg
PUL060A	L123*W79*H31mm	248g	L435*W345*H40mm	L450*W350*H180mm	36 pcs	9.00kg	11.0kg



Remarks: accessories will be packed in PE bags separately

Optional 2:

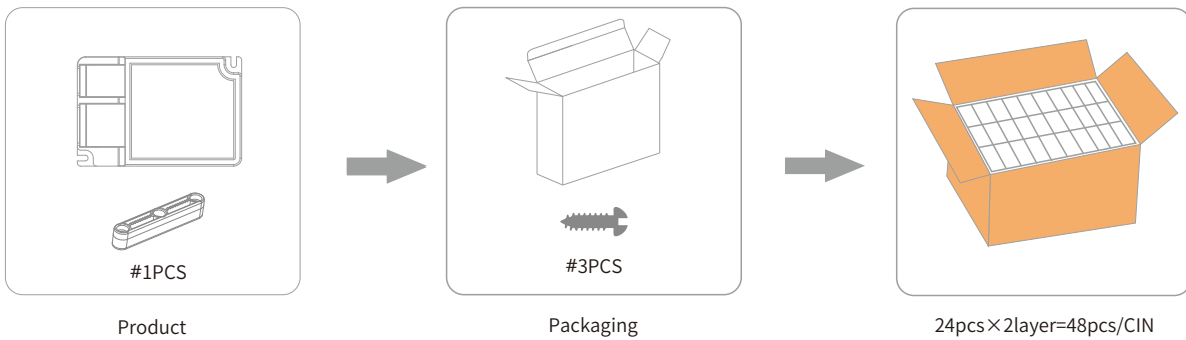

Model	Product size	Weight	Packaging size	Carton size	Qty/carton	N.W	G.W
PUL030A	L103*W68*H30mm	140g	L130*W38*H85mm	L415*W330*H190mm	48 pcs	6.8kg	9.8kg
PUL042A	L103*W68*H30mm	168g	L130*W38*H85mm	L415*W330*H190mm	48 pcs	8.1kg	11.2kg
PUL060A	L123*W79*H31mm	248g	L130*W38*H85mm	L415*W330*H190mm	48 pcs	11.9kg	14.5kg

Additional information

1. This product can only be used outside the light body, Can not be used inside of the light, and it must be used within the specified working environment.
2. The life and MTBF of the product are for reference only, and do not represent a warranty statement. If the drive has been turned on, there is no warranty.
3. For more information, please send an email to info@bokedriver.com.