

Hand Sweep/Door Control Sensor Switch Remote Controller

- Hand sweep & door control 2-in-1 function sensor switch remote controller.
- Set 3 kinds sensor switch modes by button:
 - hand sweep mode (dimmable),
 - hand sweep mode (non-dimmable),
 - door control mode.
- Operate with LED indicator light.
- CR2450 battery powered.
- Apply to cabinet, closet, wine cabinet and other lighting.

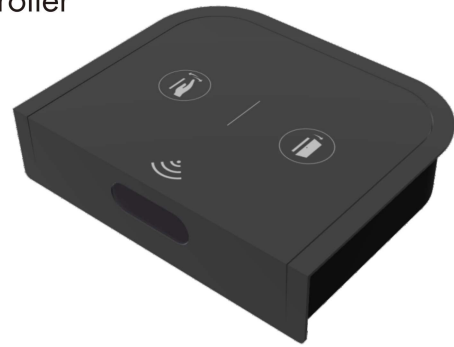

CE RoHS RED

Technical Parameters

Input and Output		Environment and Protection		Safety and EMC	
Output signal	RF(2.4GHz)	Operation temperature	Ta: -30°C ~ +50°C	EMC standard (EMC)	ETSI EN 301 489-1 V2.2.3 ETSI EN 301 489-17 V3.2.4
Control distance	10m	Package		Safety standard	EN 62368-1:2020+A11:2020
Sensing range	3-4cm			Certification	CE,EMC,RED
Work voltage	3VDC(CR2450)	Size	80x40x30mm		
Work current	Max. 4mA	Gross weight	0.038kg		
Standby current	<20uA				

Mechanical Structures and Installations

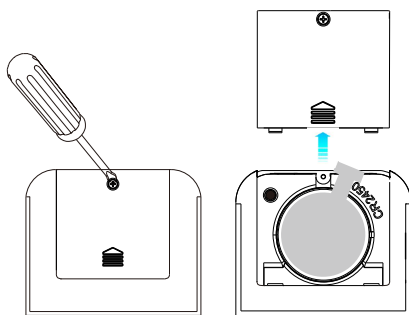
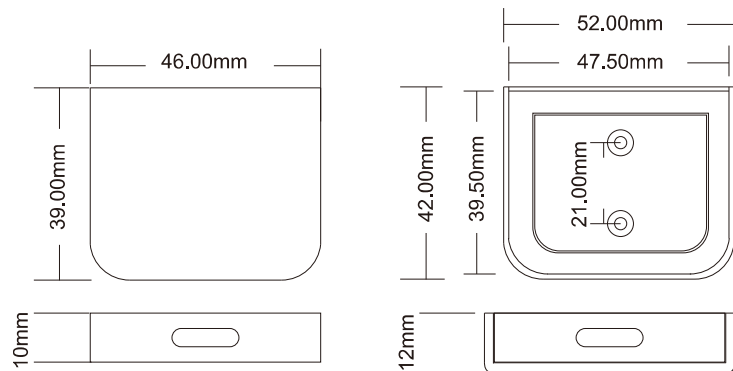
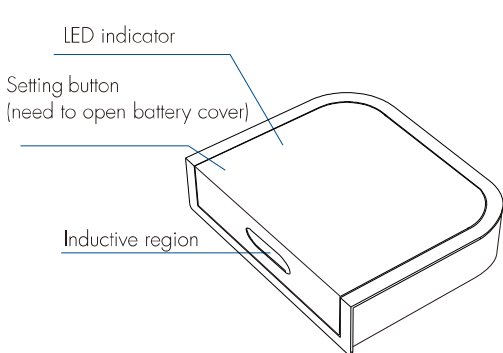

Note: Before the first use, please remove the protective film on the battery.

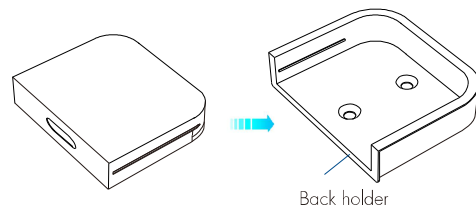

To fix the remote, two options are offered for selection:
 1. fix the remote' back holder on the wood or wall with two screws
 2. adhere it to the wood or wall with pasteur.

Induction switch mode setting

Long press the setting button for 2s to switch three working modes in sequence:

1. hand sweep mode (dimmable), the LED indicator light flashes 1 time.
2. hand sweep mode (non-dimmable), the LED indicator light flashes 2 times.
3. door control mode, the LED indicator light flashes 3 times.

Note:

Factory default working mode: hand sweep mode (dimmable).
 Sense detection is stopped when the button is set to sense switch mode.

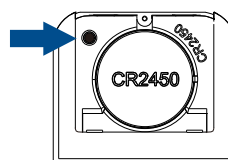

Sensor Switch Remote Control Installation

1. Use screws or 3M adhesive to fix the installation:

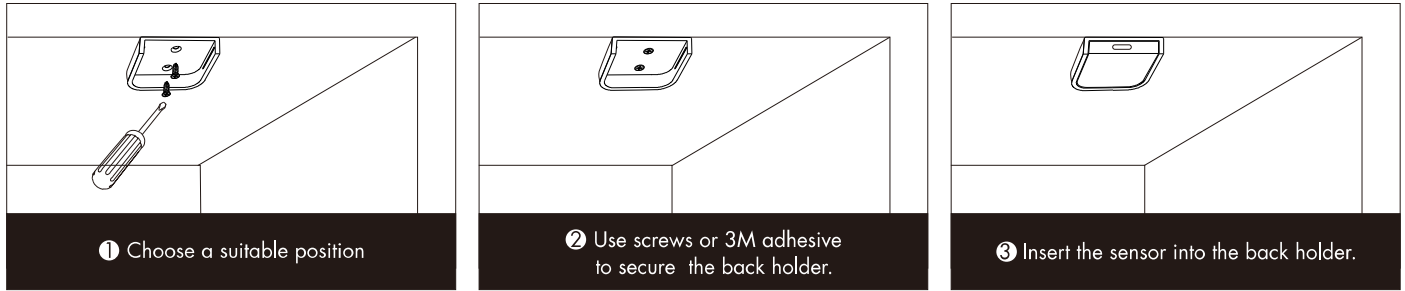

2. Slotted recessed installation:

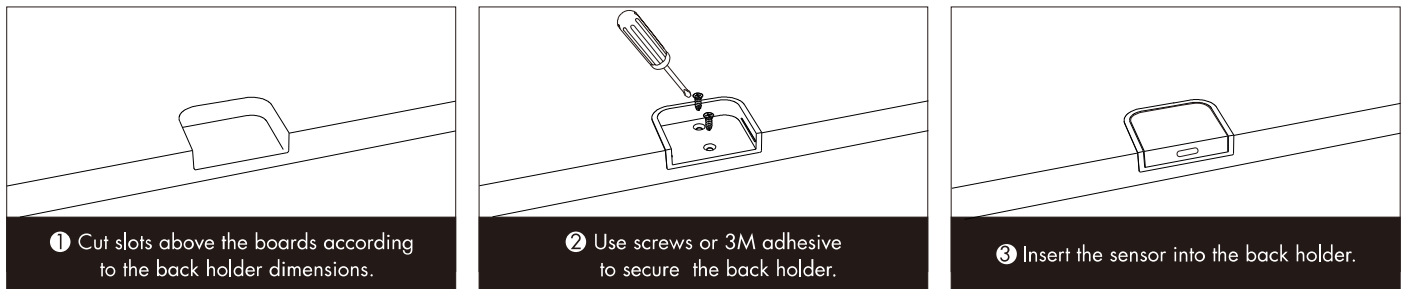

RF LED Controller Match Sensor Switch Remote Control

End user can choose the suitable match/delete ways. Two options are offered for selection:

Use the controller's Match key

Match:

Short press match key of the controller, immediately short press setting key on the remote controller or hand sweep or open / close door for a single inductive switch action. The LED indicator fast flash a few times means match is successful.

Delete:

Press and hold match key of the controller for 5s, The LED indicator fast flash a few times means match was deleted.

Use Power Restart

Match:

Switch off the power of the controller, then switch on power, repeat again. Immediately short press setting key 3 times on the remote controller, or hand sweep or open / close door for 3 times quick inductive switch action. The controller output light blinks 3 times means match is successful.

Delete:

Switch off the power of the controller, then switch on power, repeat again. Immediately short press setting key 5 times on the remote controller, or hand sweep or open / close door for 3 times quick inductive switch action. The controller output light blinks 5 times means match was deleted.

Sensor Switch Remote Control Application

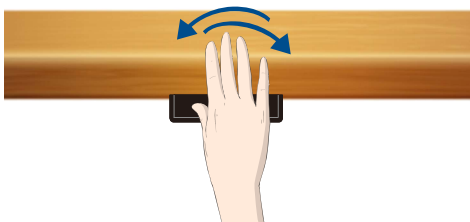

1. Hand-sweep mode (dimmable):

Make pendulum action at the front end of the sensing region: when hand sweep, the light turn on gradually; when hand sweep again, the light turn off gradually.

Hold your hand in front of the sensing head for more than 2 seconds: The brightness increases or decreases continuously, the each time the hand is removed and then held again, the brightness changes in the opposite direction.

2. Hand-sweep mode (non-dimmable):

Make pendulum action at the front end of the sensing region: when hand sweep, the light turn on gradually; when hand sweep again, the light turn off gradually. Hand sweep switch only, no dimming function when hand stays.



3. Door control mode:

Use the door as a reflection object. It is installed at the outer edge of the cabinet door.

When the door open, or no obstacle in front of the sensing region, the light turn on gradually; When the door close, or obstacle in front of the sensing region, the light turn off gradually.