

Touch Wheel RF Remote Controller

Model No.: RT1/RT6/RT8

1, 4, 8 zone dimming/Touch color wheel/Wireless remote 30m distance/AAAx2 battery



RT1
1 Zone Dimming



RT6
4 Zone Dimming



RT8
8 Zone Dimming

Features

- Apply to single color LED controller.
- Ultra sensitive color adjustment touch wheel.
- Each remote can match one or more receiver.
- AAAx2 battery powered.
- Operate with LED indicator light.

CE RoHS LVD RED

Technical Parameters

Input and Output		Safety and EMC	
Output signal	RF(2.4GHz)	EMC standard (EMC)	EN301 489, EN 62479
Working voltage	3VDC(AAAx2)	Safety standard(LVD)	EN60950
Working current	< 5mA	Radio Equipment(RED)	EN300 328
Standby current	< 10µA	Certification	CE, EMC, LVD, RED
Standby time	1 year		
Remote distance	30m(Barrier-free space)		
Environment		Warranty	
Operation temperature	Ta: -30°C ~ +55°C	Warranty	5 years
IP rating	IP20		
		Weight	
		Net weight	0.048kg
		Gross weight	0.088kg

Mechanical Structures and Installations

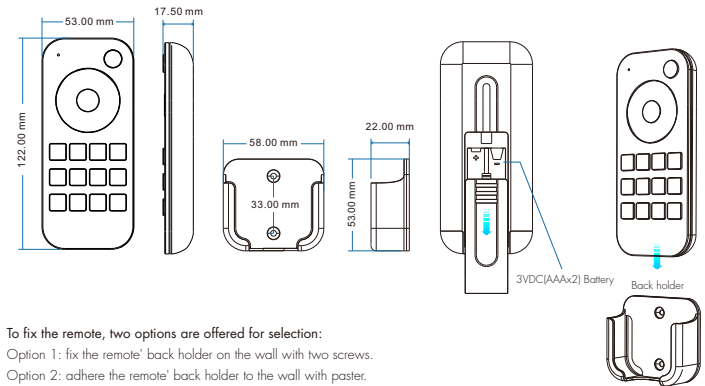

To fix the remote, two options are offered for selection:

Option 1: fix the remote' back holder on the wall with two screws.

Option 2: adhere the remote' back holder to the wall with pasteur.

Operation

- When turn on light, the indicator display blue. when turn off light, the indicator display red.
- When touch the color wheel, the indicator will display the same color.
- When press or touch operation is invalid (If the light is off), the indicator display red.
- To extend battery life, no touch or press key operation after a few seconds, the touch wheel will enter sleep state, you need press any key to make touch wheel quit sleep state.

Match Remote Control (two match ways)

End user can choose the suitable match/delete ways. Two options are offered for selection:

Use the controller's Match key

Match:

Short press match key, immediately press on/off key (single zone remote) or zone key (multiple zone remote) of the remote.

The LED indicator fast flash a few times means match is successful.

Delete:

Press and hold match key for 5s to delete all match, The LED indicator fast flash a few times means all matched remotes were deleted.

Use Power Restart

Match:

Switch off the power, then switch on power again, immediately short press on/off key (single zone remote) or zone key (multiple zone remote) 3 times on the remote. The light blinks 3 times means match is successful.

Delete:

Switch off the power, then switch on power again, immediately short press on/off key (single zone remote) or zone key (multiple zone remote) 5 times on the remote. The light blinks 5 times means all matched remotes were deleted.

Key function





• RT1 1 zone dimming remote



-  : Turn on/off light.
-  : Touch to change brightness.
-  : Adjust brightness, short press 10 levels, long press 1-6s for continuous 256 levels adjustment.
-  : Small night brightness (10%).
-  : Turn off light after 30s, long press 2s will turn off light after 60s.
-  : 25%, 50%, 75%, 100% brightness.
-  : Short press recall the scene, long press 2s save current brightness into S1/2/3/4. the LED indicator display green when save OK.





• RT6 4 zone dimming remote



-  : Short press turn on/off all zone light.
-  : Touch to change current zone brightness.
-  : Short press select and turn on zone light, long press 2s turn off zone light. Short press multiple zone key fastly, will select multiple zone synchronously.
-  : 25%, 50%, 75%, 100% brightness for current selected zone.
-  : Short press recall the scene, long press 2s save current state into S1/2/3/4. the LED indicator display green when save OK. 4 zone recall or save synchronously.

• RT8 8 zone dimming remote



-  : Short press turn on/off all zone light.
-  : Touch to change current zone brightness.
-  : Short press select and turn on zone light, long press 2s turn off zone light. Short press multiple zone key fastly, will select multiple zone synchronously.
-  : Short press recall the scene, long press 2s save current state into S1/2/3/4. the LED indicator display green when save OK. 8 zone recall or save synchronously.

Safety information

1. Read all instructions carefully before you begin this installation.
2. When installing battery, pay attention to the battery positive and negative polarity.
A long time without the remote control, remove the battery.
When remote distance becomes smaller and insensitive, replace the battery.
3. If no response from the receiver, please re-match the remote.
4. Gently handle remote, beware of falling.
5. For indoor and dry location use only.